

# **ISIS** Network-based **P**latform

**Rodrigo Dias Arruda Senra**

# My background

- BIREME's collaborator since 2006
- Software Architect and Developer  
*GPr Sistemas since 1996*
- Computer Engineer and PhD student  
*IC/Unicamp*
- **newbie/novato in ISIS world**



# Who is in the audience ?

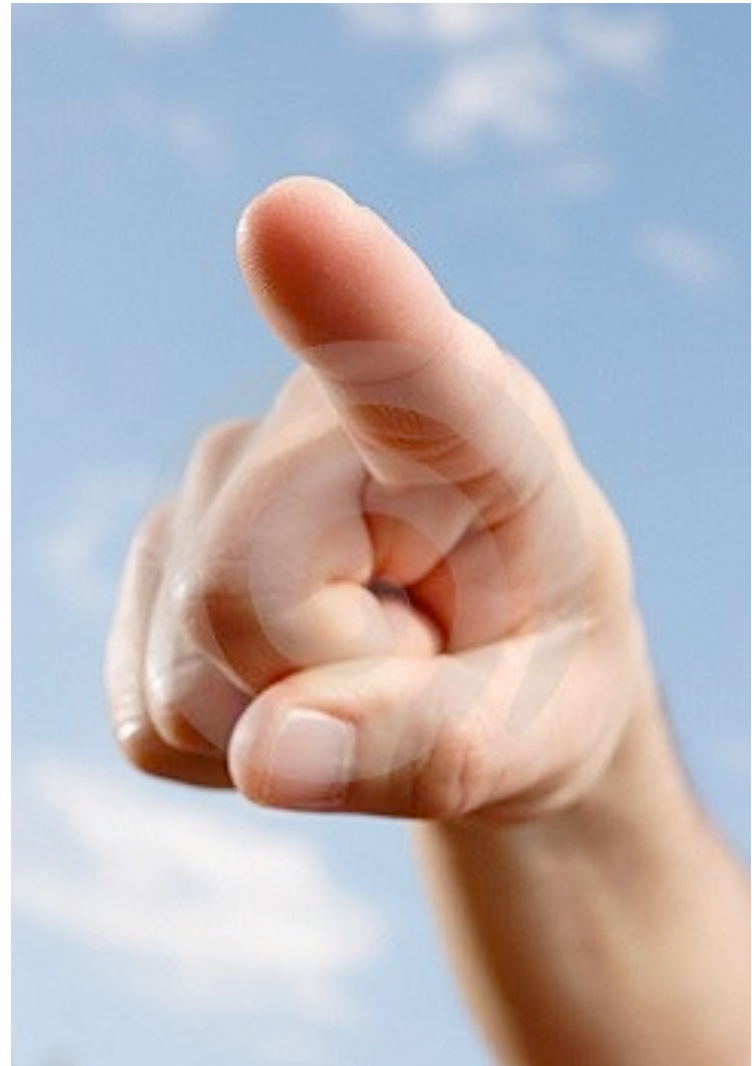

# Who is in the audience ?

✓ CDS/ISIS mailinglist subscribers ?



# Who is in the audience ?

- ✓ CDS/ISIS mailinglist subscribers ?
- ✓ ISIS Users ?



# Who is in the audience ?

- ✓ CDS/ISIS mailinglist subscribers ?
- ✓ ISIS Users ?
- ✓ Librarians ?



# Who is in the audience ?

- ✓ CDS/ISIS mailinglist subscribers ?
- ✓ ISIS Users ?
- ✓ Librarians ?
- ✓ Software developers ?



# Who is in the audience ?

- ✓ CDS/ISIS mailinglist subscribers ?
- ✓ ISIS Users ?
- ✓ Librarians ?
- ✓ Software developers ?
- Not covered above!





# Presentation Outline

# Presentation Outline

- Contextualizing ISIS-NBP

# Presentation Outline

- Contextualizing ISIS-NBP
- What is ISIS-NBP ?
  - ▶ vision / architecture /scenarios

# Presentation Outline

- Contextualizing ISIS-NBP
- What is ISIS-NBP ?
  - ▶ vision / architecture /scenarios
- Project status
  - ▶ Past / Present / Future

# Presentation Outline

- Contextualizing ISIS-NBP
- What is ISIS-NBP ?
  - ▶ vision / architecture /scenarios
- Project status
  - ▶ Past / Present / Future
- Demonstration

# Presentation Outline

- Contextualizing ISIS-NBP
- What is ISIS-NBP ?
  - ▶ vision / architecture /scenarios
- Project status
  - ▶ Past / Present / Future
- Demonstration
- Development
  - ▶ client applications for ISIS-NBP
  - ▶ ISIS-NBP itself

# Presentation Outline

- Contextualizing ISIS-NBP
- What is ISIS-NBP ?
  - ▶ vision / architecture /scenarios
- Project status
  - ▶ Past / Present / Future
- Demonstration





# ISIS-NBP in Context

# History

# History

April 2006

- first contact with BIREME
- connect Isis to Plone/Zope !?

# History

April 2006

May 2006

- Unesco Headquarters in Paris
- new open source network-based ISIS project

# History

April 2006

May 2006

January 2007

- my first contact with CDS/ISIS Mini-micro Manual

# History

April 2006

May 2006

January 2007

July 2007

- released ISIS-NBP Vision Report

# History

April 2006

May 2006

January 2007

July 2007

April 2008

- ISIS-NBP prototype 0.1

# History

April 2006

May 2006

January 2007

July 2007

April 2008

**September 2008**

- released ISIS-NBP 0.8 in the III World Meeting of CDS/ISIS



# Myths: ISIS-NBP...

# Myths: ISIS-NBP...

- ... is ready for prime time!

# Myths: ISIS-NBP...

- ... is ready for prime time!
- ...is an application

# Myths: ISIS-NBP...

- ... is ready for prime time!
- ...is an application
- ... is a revolution in ISIS world

# Myths: ISIS-NBP...

- ... is ready for prime time!
- ...is an application
- ... is a revolution in ISIS world
- ... is proprietary closed-source under the control of an evil empire

# Myths: ISIS-NBP...

- ... is ready for prime time!
- ...is an application
- ... is a revolution in ISIS world
- ... is proprietary closed-source under the control of an evil empire
- ... is for Unix programmers or old DOS users

# Truths: ISIS-NBP...

- ... is ready for prime time!
- ...is an application
- ... is a revolution in ISIS world
- ... is proprietary closed-source under the control of an evil empire
- ... is for Unix programmers or old DOS users

# Truths: ISIS-NBP...

- ... is under development
- ...is an application
- ... is a revolution in ISIS world
- ... is proprietary closed-source under the control of an evil empire
- ... is for Unix programmers or old DOS users



# Truths: ISIS-NBP...

- ... is under development
- ...is a platform
- ... is a revolution in ISIS world
- ... is proprietary closed-source under the control of an evil empire
- ... is for Unix programmers or old DOS users

# Truths: ISIS-NBP...

- ... is under development
- ...is a platform
- ... is *hopefully* evolution in ISIS world
- ... is proprietary closed-source under the control of an evil empire
- ... is for Unix programmers or old DOS users

# Truths: ISIS-NBP..

- ... is under development
- ...is a platform
- ... is *hopefully* evolution in ISIS world
- ... is release through an open license and should be a community effort
- ... is for Unix programmers or old DOS users

# Truths: ISIS-NBP...

- ... is under development
- ...is a platform
- ... is *hopefully* evolution in ISIS world
- ... is release through an open license and should be a community effort
- ..., for the time being, targets developers.  
But any tribe is welcome to try it! 😊 😊



**Vision**

# Goals





- overcome ISIS limitations in capacity
- support i18n, l10n, Unicode
- improve software and data maintenance
- flexible, scalable and interoperable
- compatible with ISIS
- add new functionality
- FOSS methodology

**larger** fields, records,  
files, and databases

- overcome ISIS limitations in capacity
- support i18n, l10n, Unicode
- improve software and data maintenance
- flexible, scalable and interoperable
- compatible with ISIS
- add new functionality
- FOSS methodology

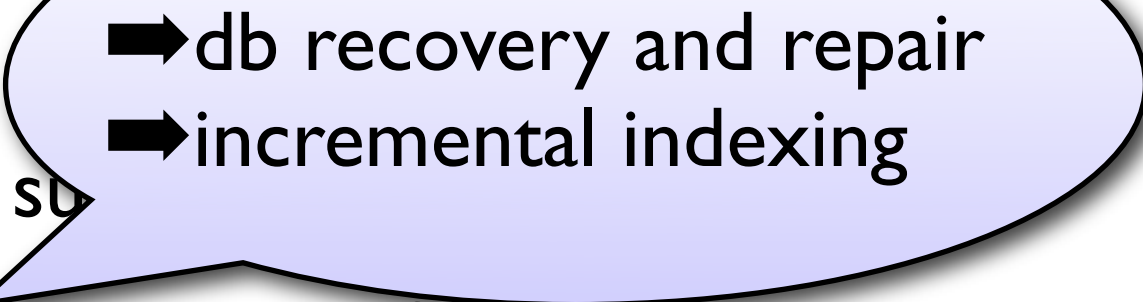

# Goals

-   db recovery and repair city
-  incremental indexing
-  su
- improve software and data maintenance
- flexible, scalable and interoperable
- compatible with ISIS
- add new functionality
- FOSS methodology

# Goals

- overcome ISIS complexity
- smooth migration path
- preserve formatting language
- evolutive and incremental deploy
- flexible
- compatible with ISIS
- add new functionality
- FOSS methodology

# Goals

- over capacity
- unlimited field nesting
- metadata composability
- full-document storage
- accommodate new media
- semantic web adherence
- add new functionality
- FOSS methodology

# Goals

- overcome ISIS limitations in capacity
- support i18n, l10n, Unicode
- improve performance

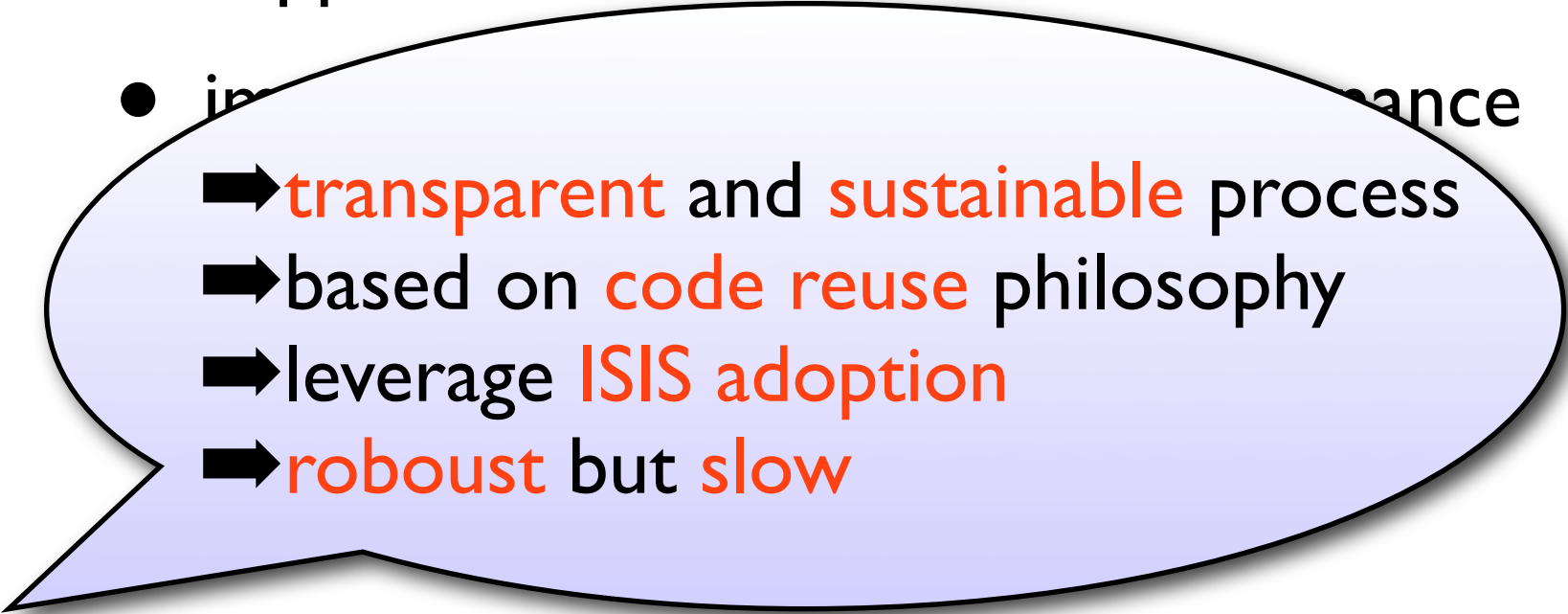

- ➔ transparent and sustainable process
- ➔ based on code reuse philosophy
- ➔ leverage ISIS adoption
- ➔ robust but slow

- FOSS methodology

# Goals

- overcome ISIS limitations in capacity
- support i18n, l10n, Unicode
- improve software and data maintenance
- flexible, scalable and interoperable
- compatible with ISIS
- add new functionality
- FOSS methodology

# Proposal

- Rethink the storage
- Rethink the model
- Improve scalability
- Increase interoperability
- Migration path

# Proposal

- Rethink the storage
- Rethink the model
- Improve scalability
- Increase interoperability
- Migration path
- support XML

# Proposal

- Rethink the storage
- Rethink the model
- Improve scalability
- Increase interoperability
- Migration path
- support XML
- multiple backends



# Proposal

- Rethink the storage
- Rethink the model
- Improve scalability
- Increase interoperability
- Migration path
- support XML
- multiple backends
- ISIS-NBP Cells

# Proposal

- Rethink the storage
- Rethink the model
- Improve scalability
- Increase interoperability
- Migration path
- support XML
- multiple backends
- ISIS-NBP Cells
- multi-protocol

# Proposal

- Rethink the storage
- Rethink the model
- Improve scalability
- Increase interoperability
- Migration path
- support XML
- multiple backends
- ISIS-NBP Cells
- multi-protocol
- **First priority!**



**Architecture**

# Classic ISIS Tools and Applications

# Classic ISIS Tools and Applications



Engine

# Classic ISIS Tools and Applications

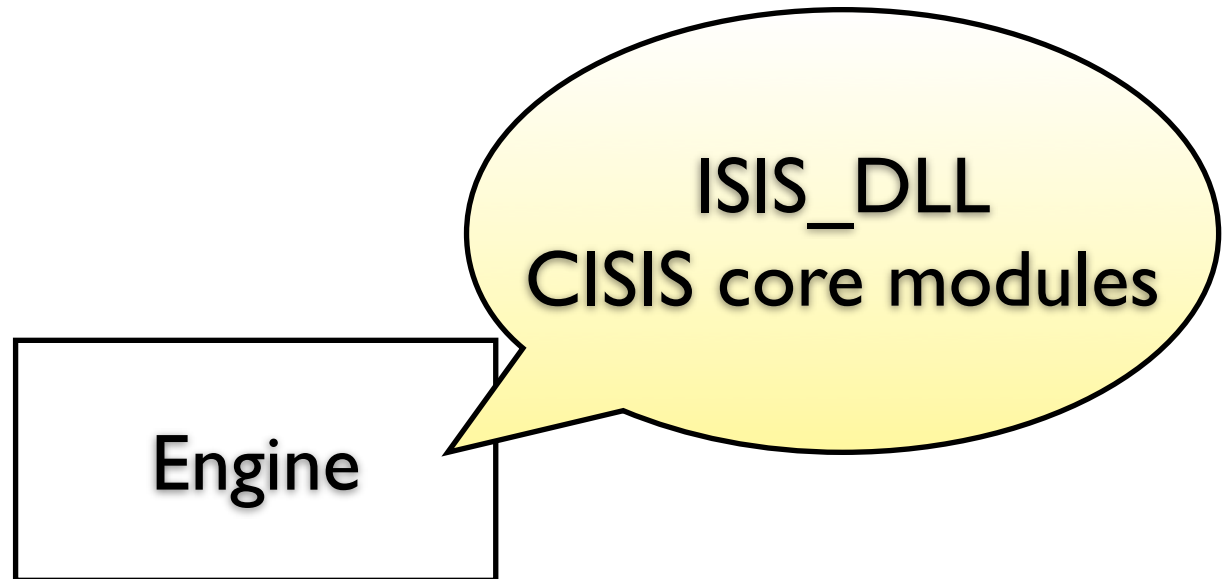



# Classic ISIS Tools and Applications



Engine

# Classic ISIS Tools and Applications

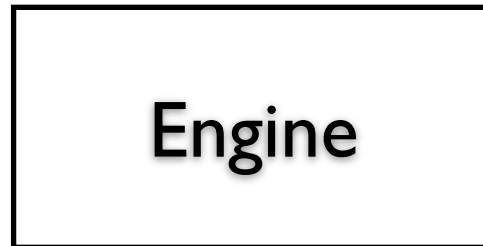
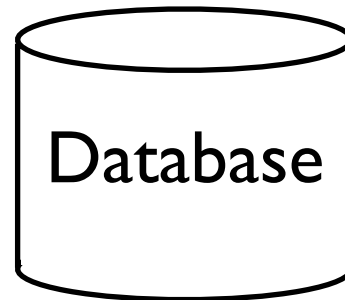

# Classic ISIS Tools and Applications

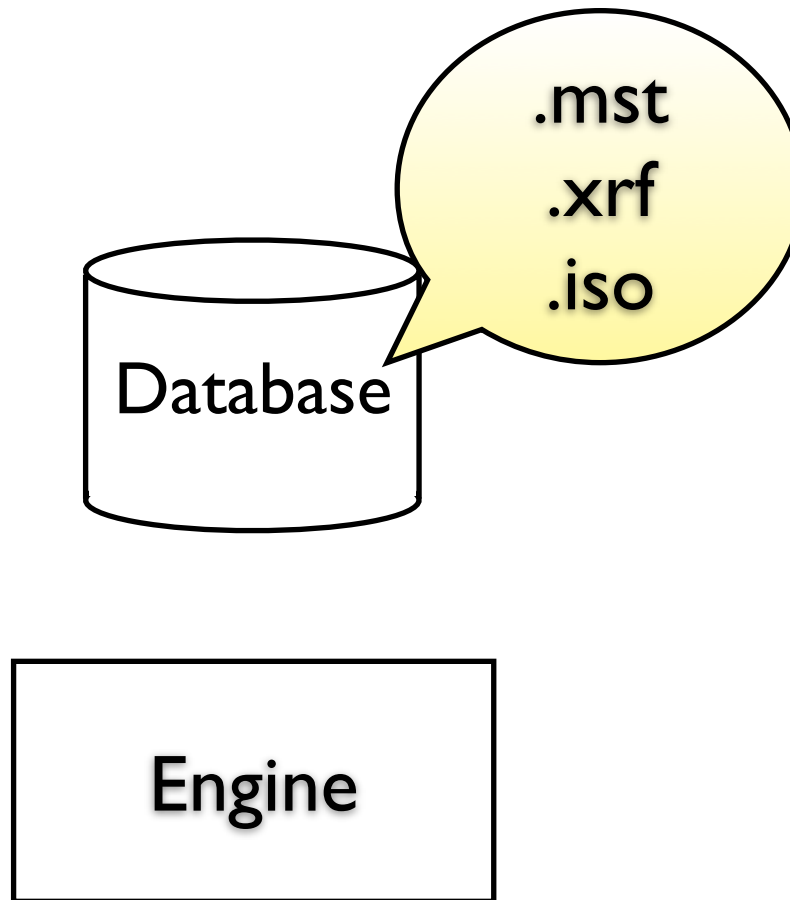

# Classic ISIS Tools and Applications

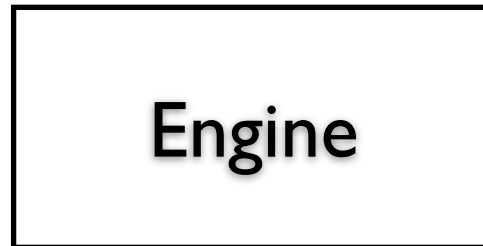
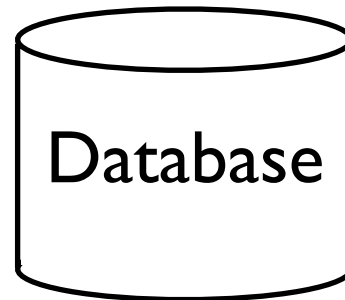

# Classic ISIS Tools and Applications

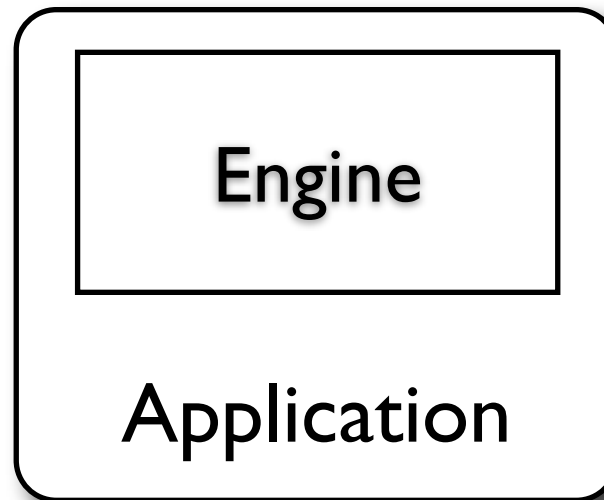
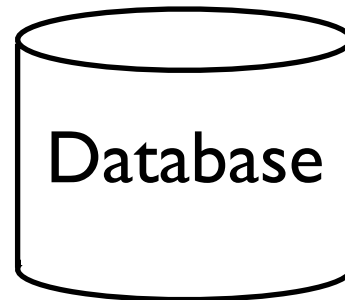

# Classic ISIS Tools and Applications

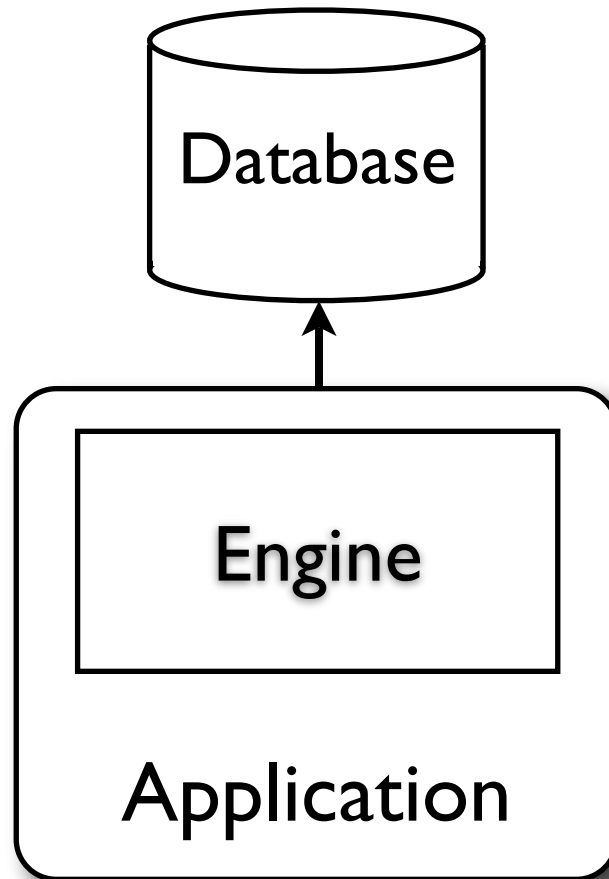

# Classic ISIS Tools and Applications

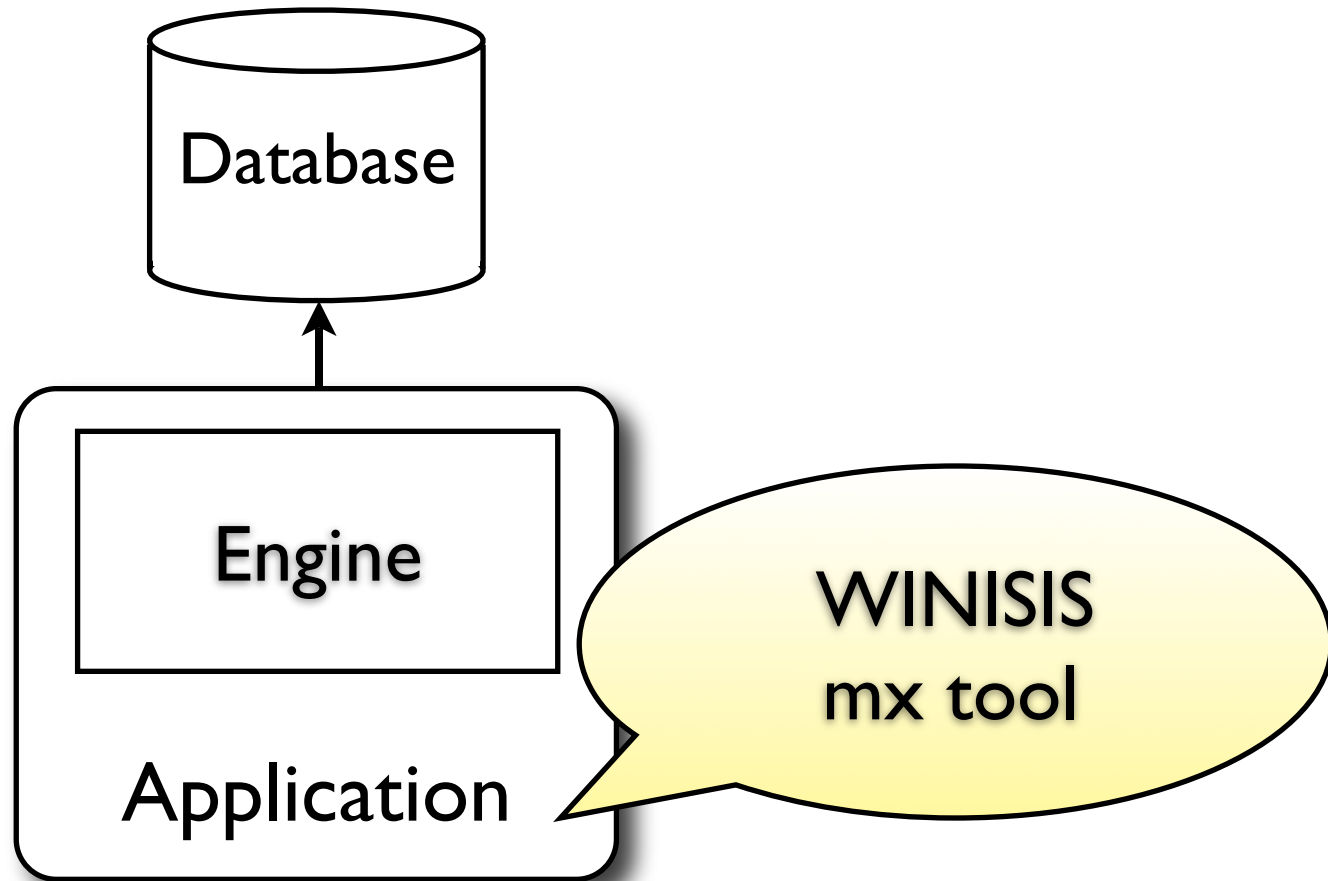

# Classic ISIS Tools and Applications

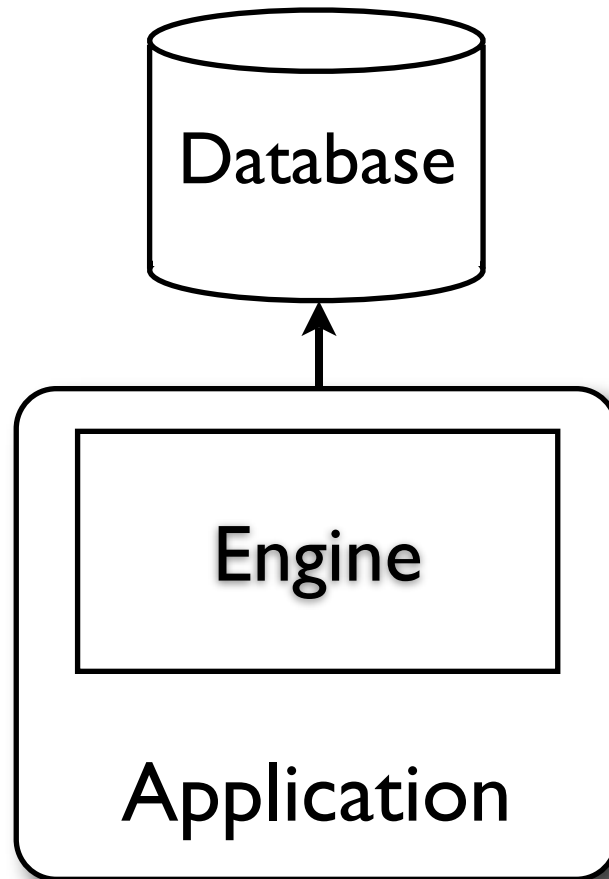



# Classic ISIS Tools and Applications

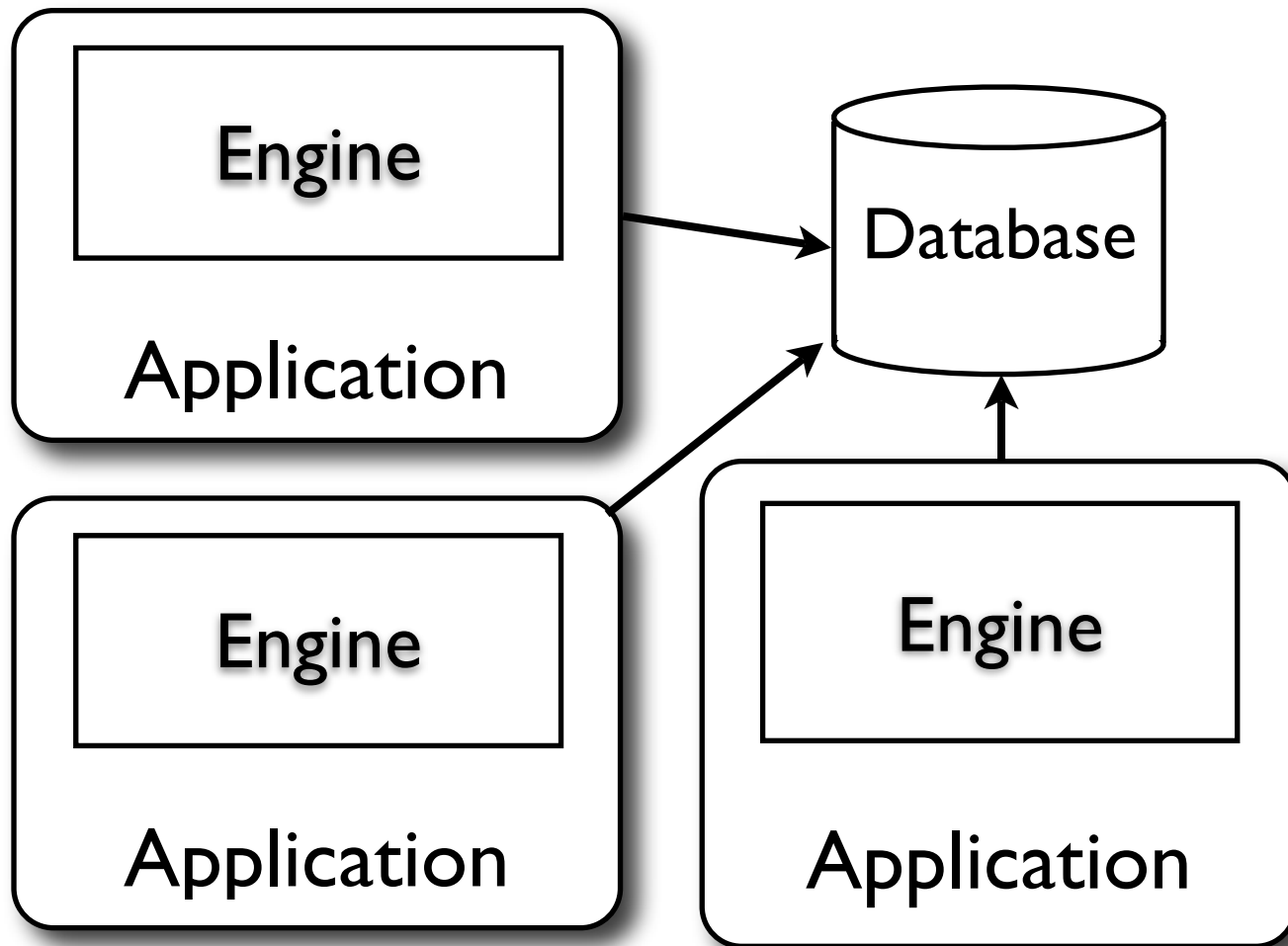

# ISIS Architecture

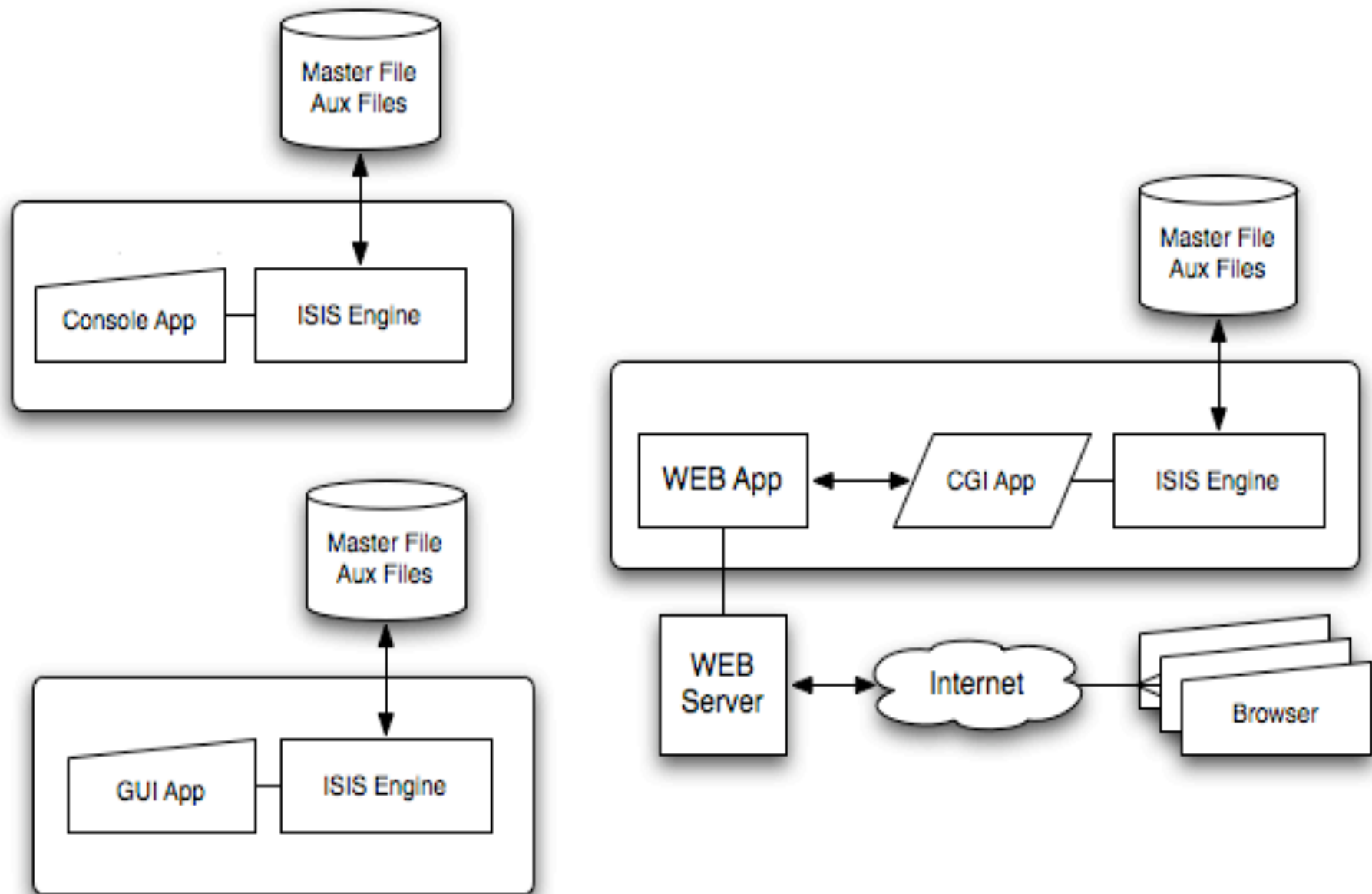

# ISIS-NBP Cell

# ISIS-NBP Cell



Engine

# ISIS-NBP Cell

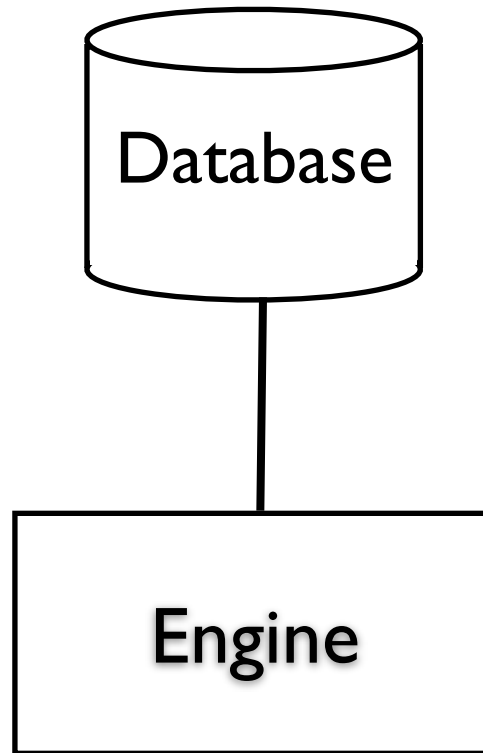

# ISIS-NBP Cell

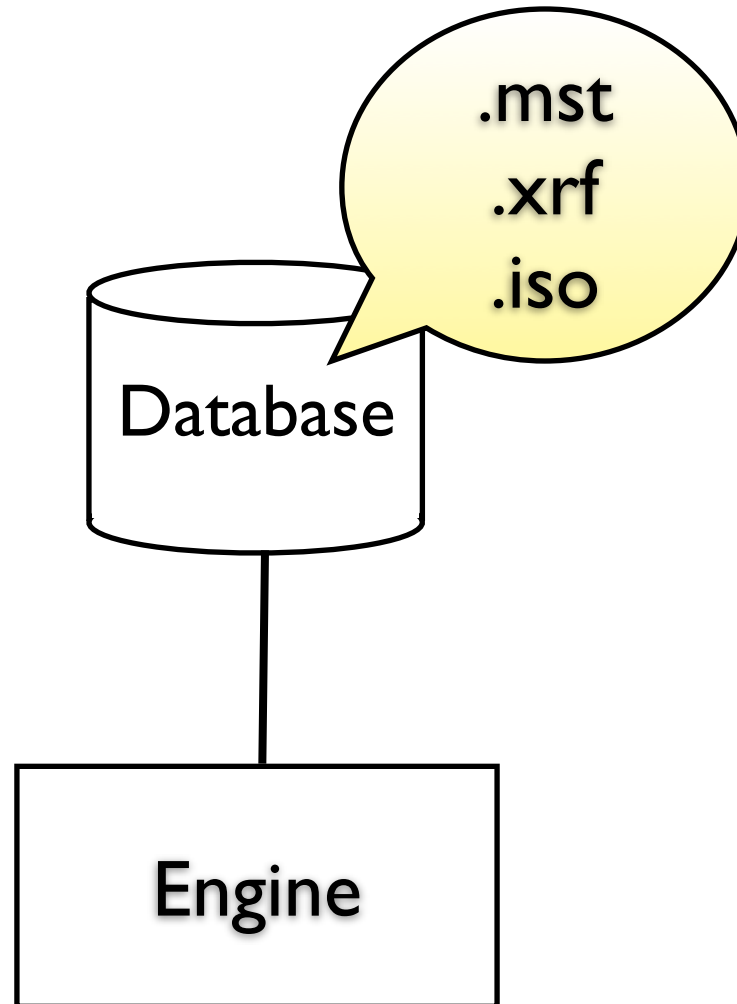

# ISIS-NBP Cell

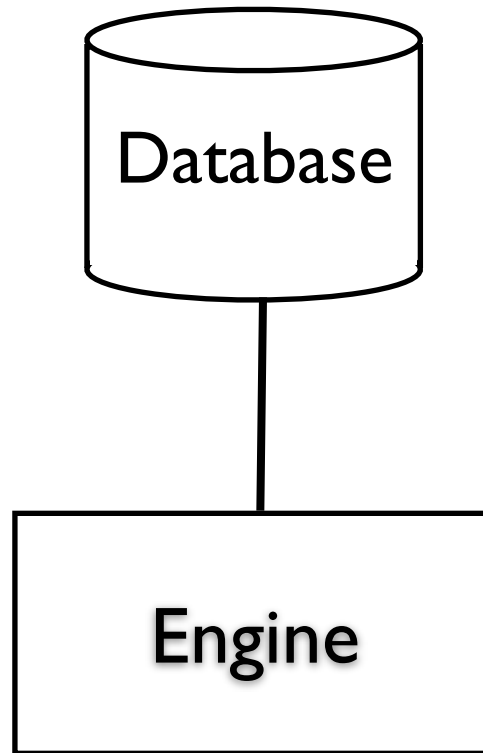

# ISIS-NBP Cell

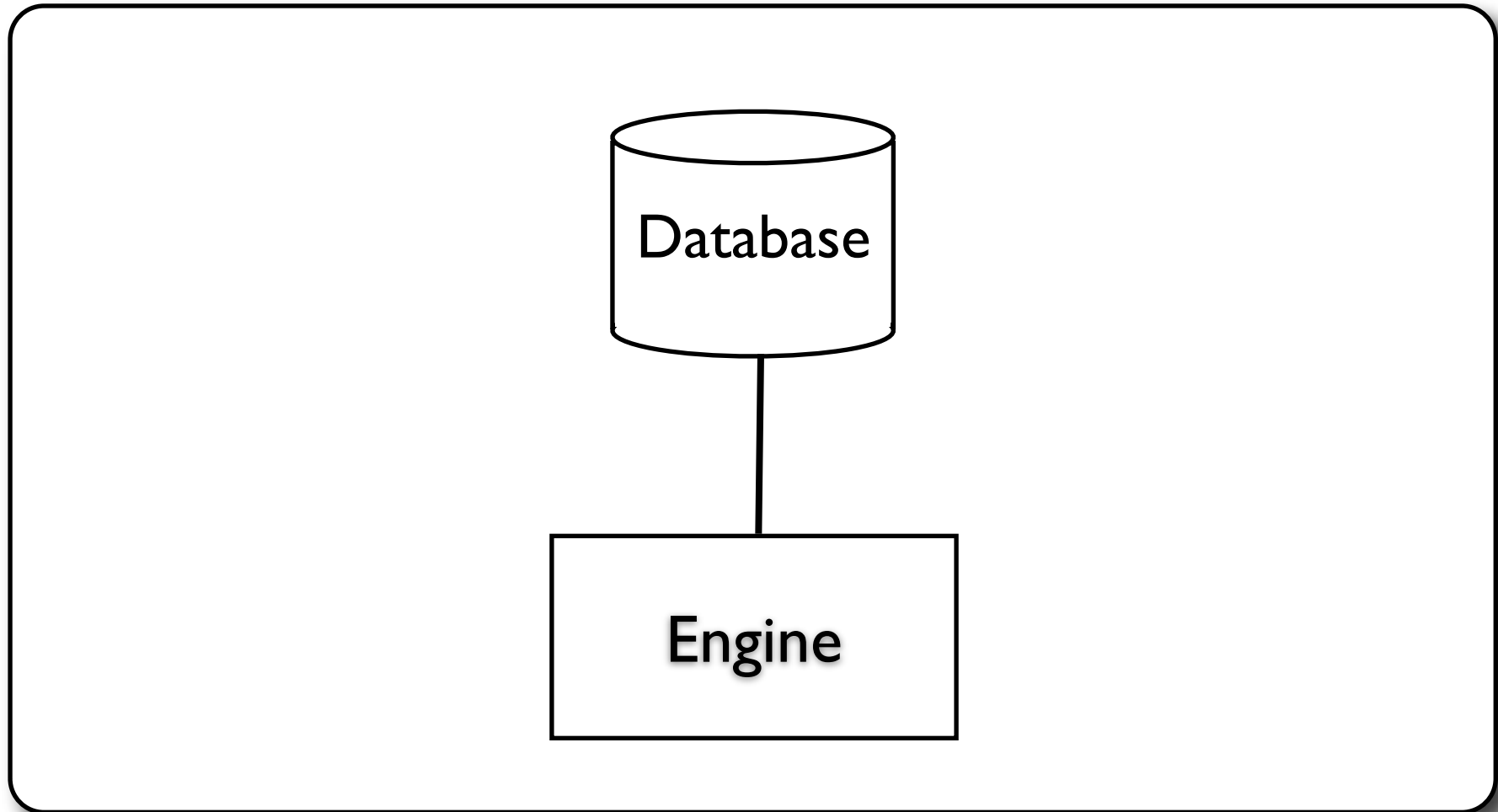



# ISIS-NBP Cell

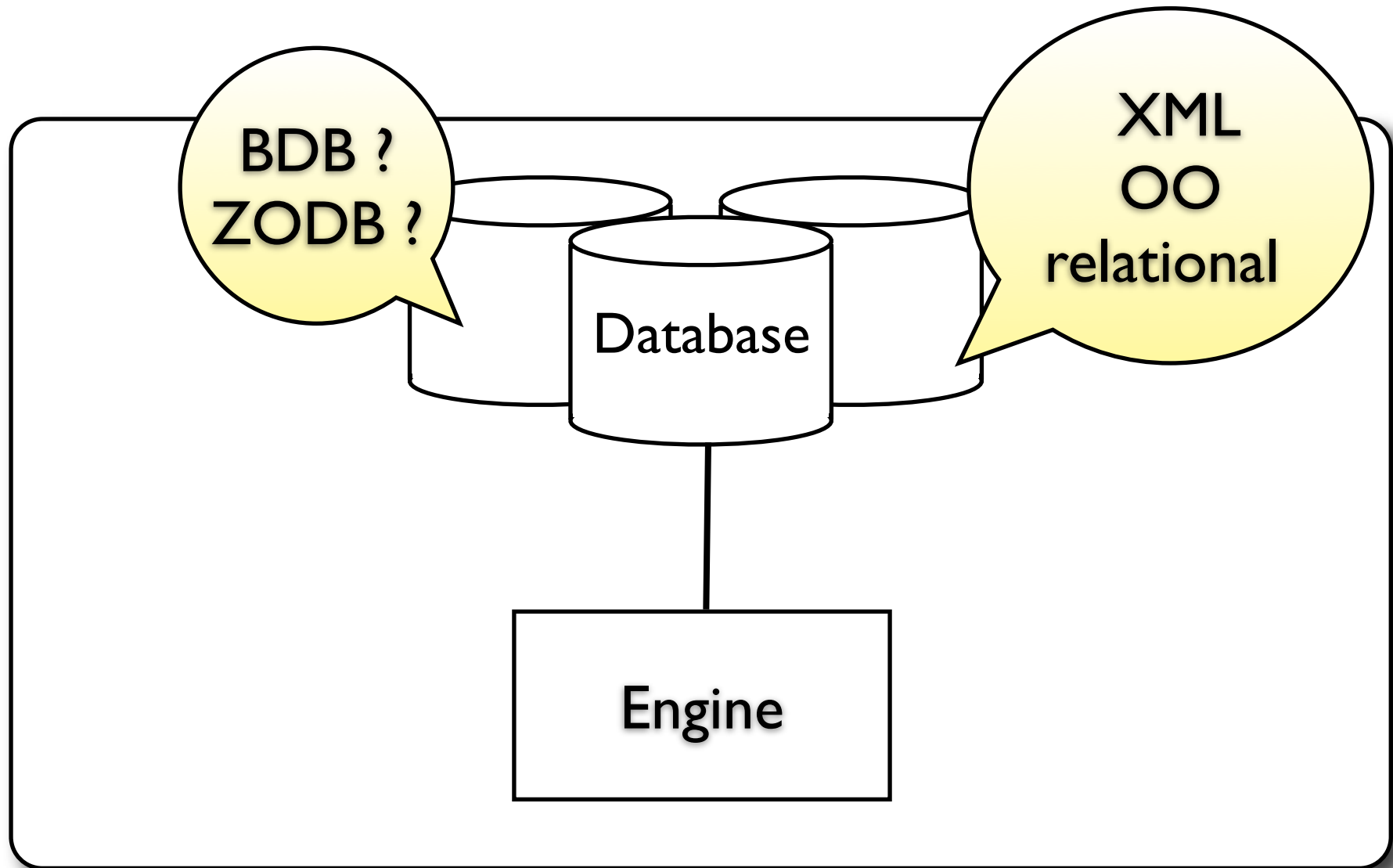

# ISIS-NBP Cell

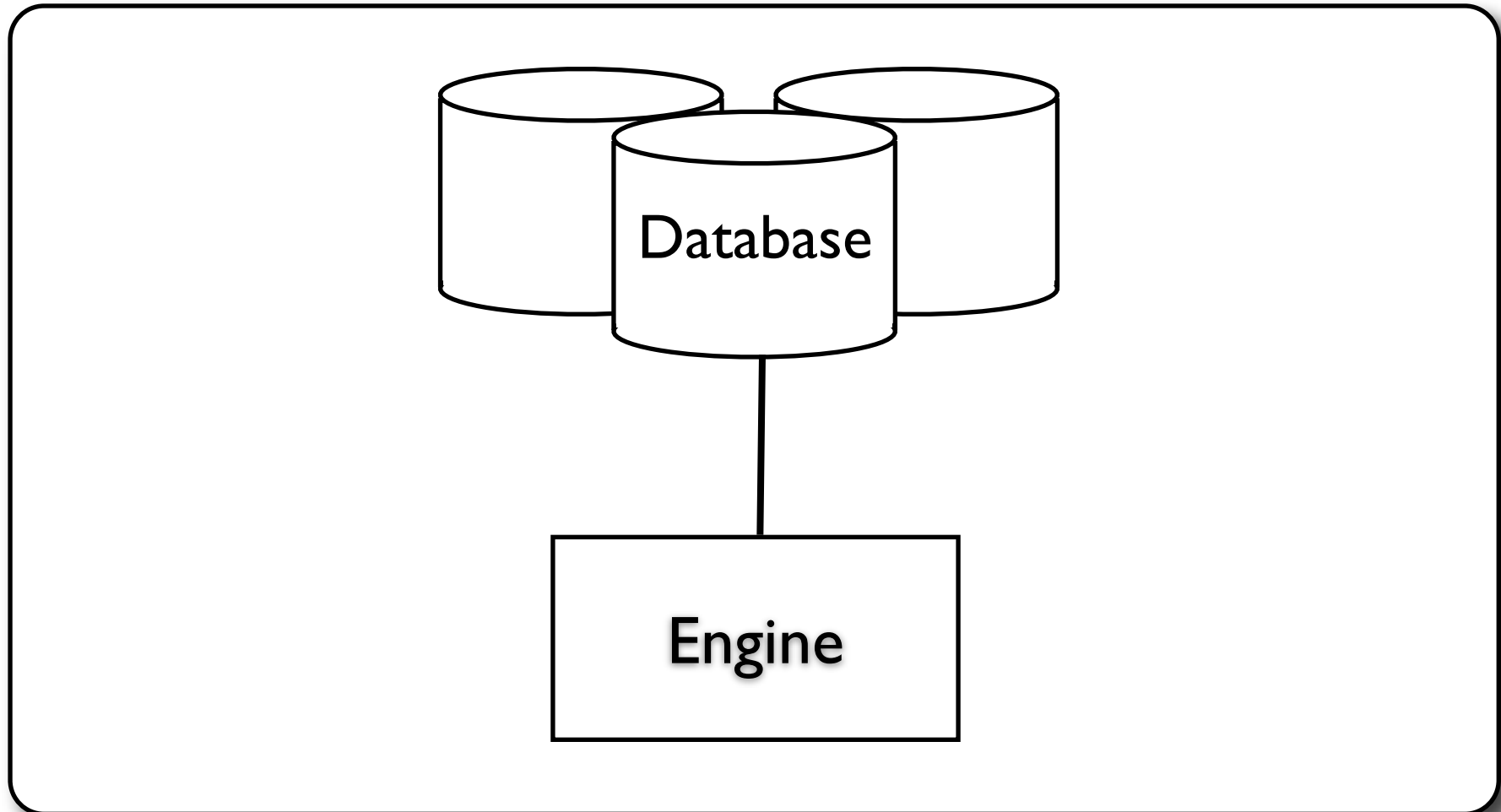

# ISIS-NBP Cell

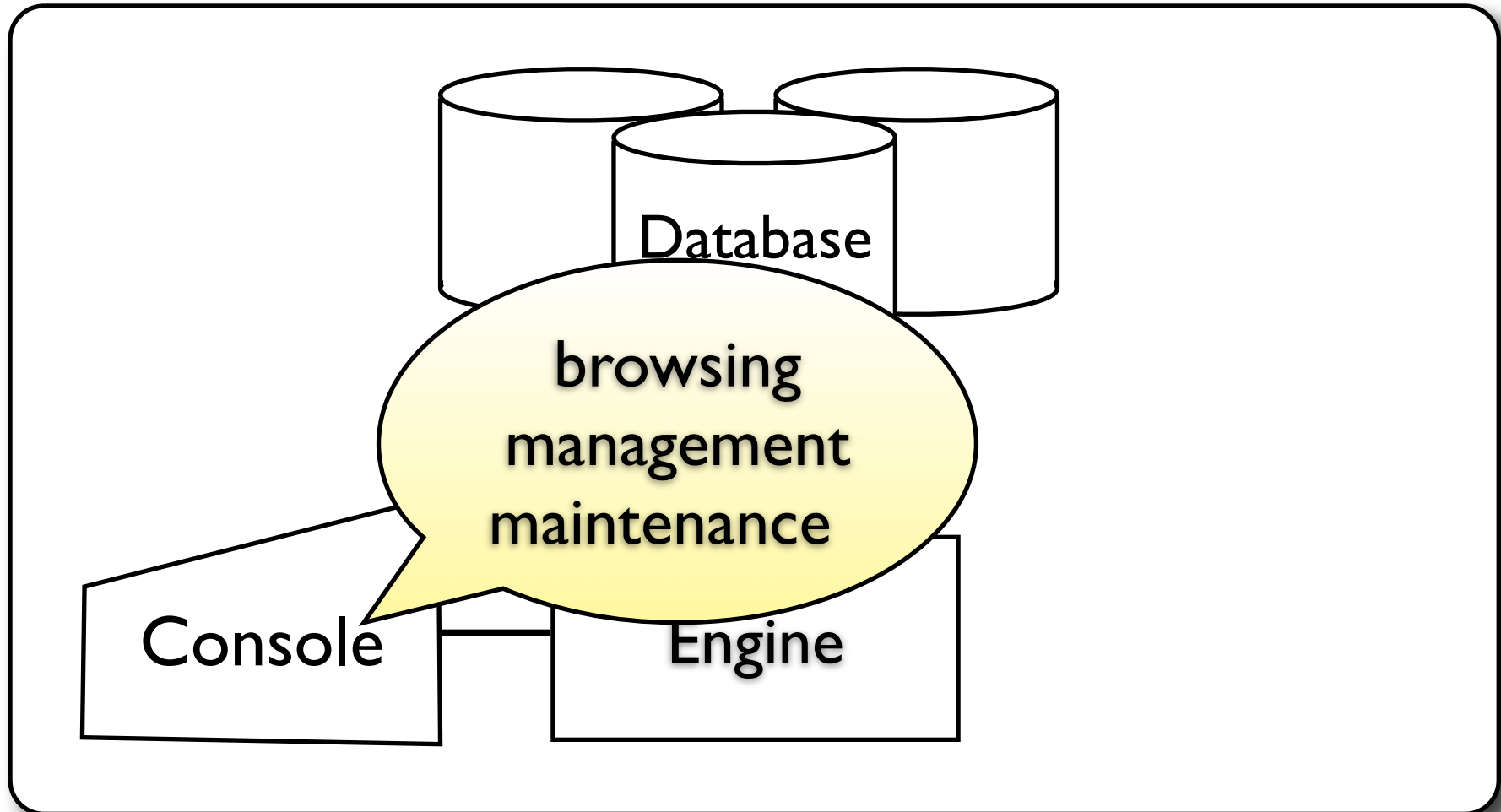

# ISIS-NBP Cell

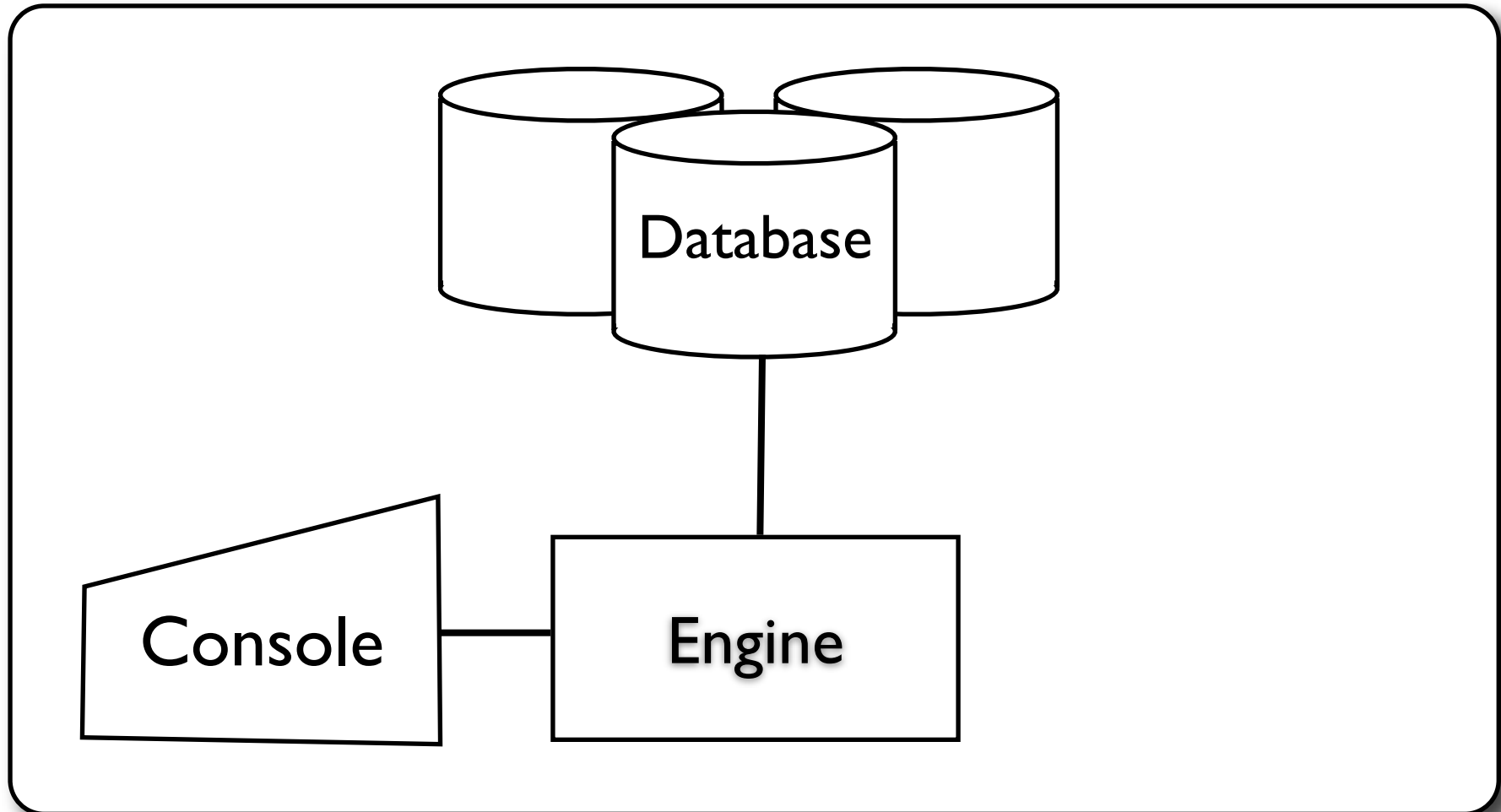

# ISIS-NBP Cell

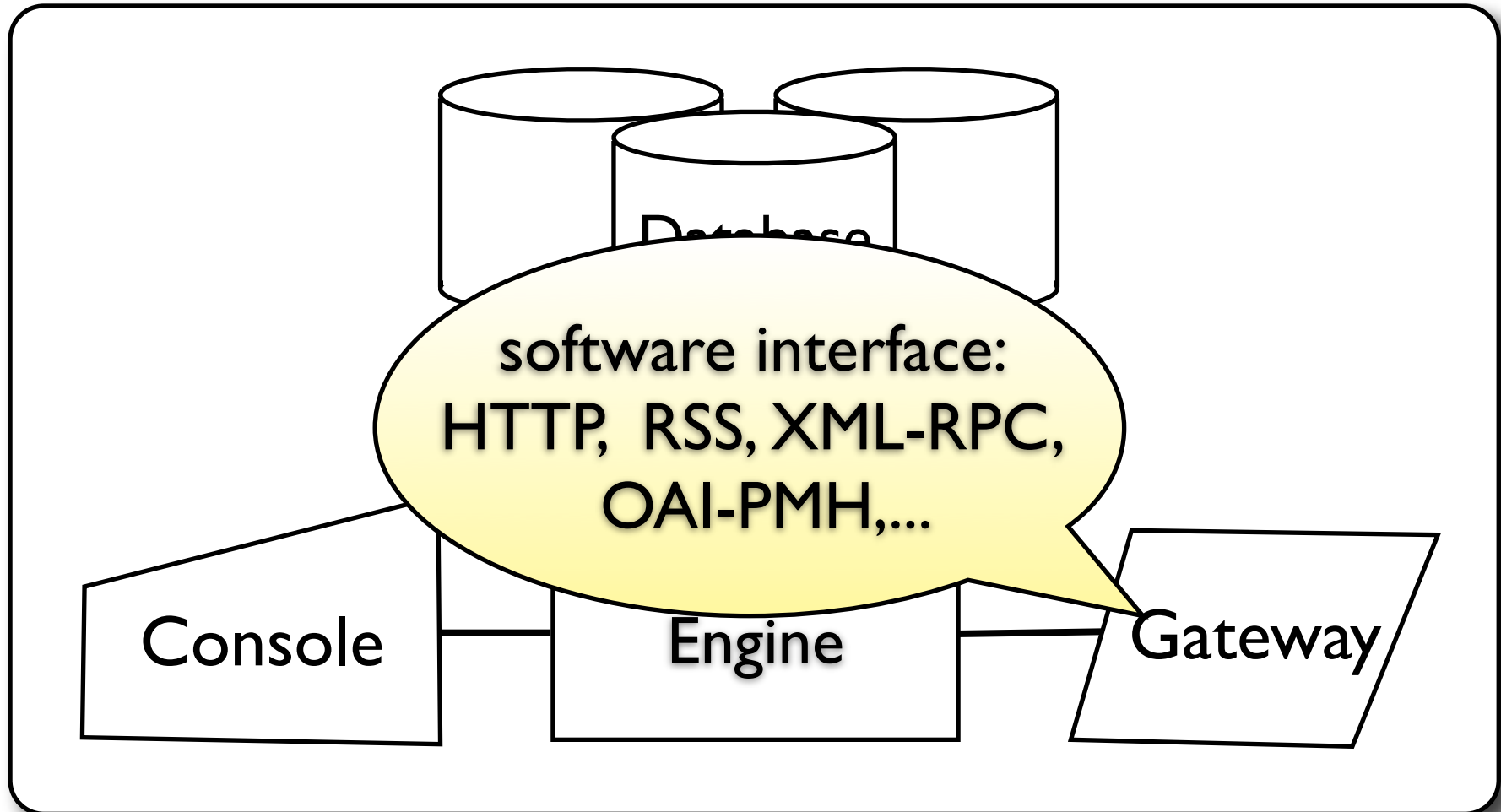

# ISIS-NBP Cell

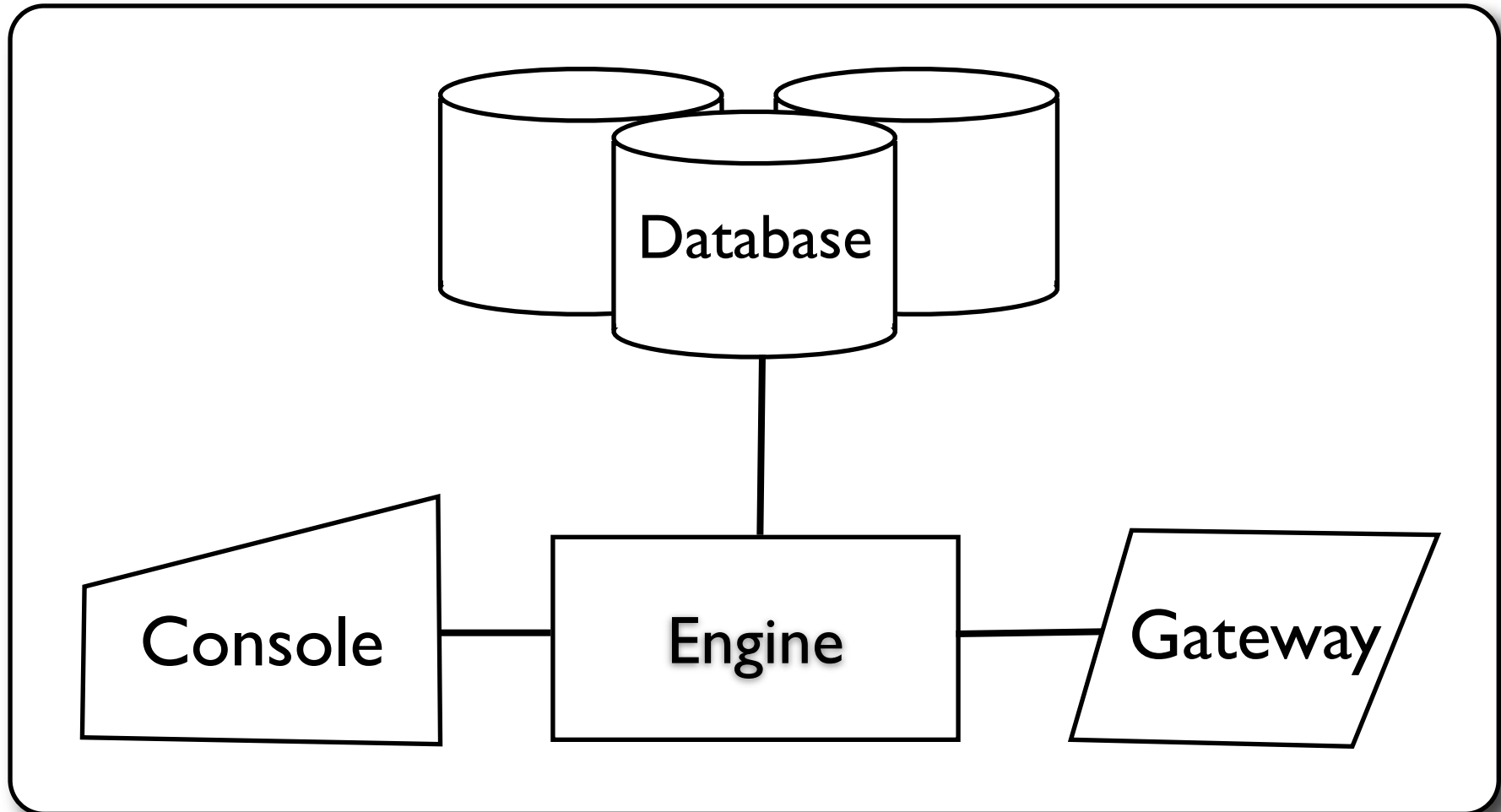



# Scenarios



# Scenarios

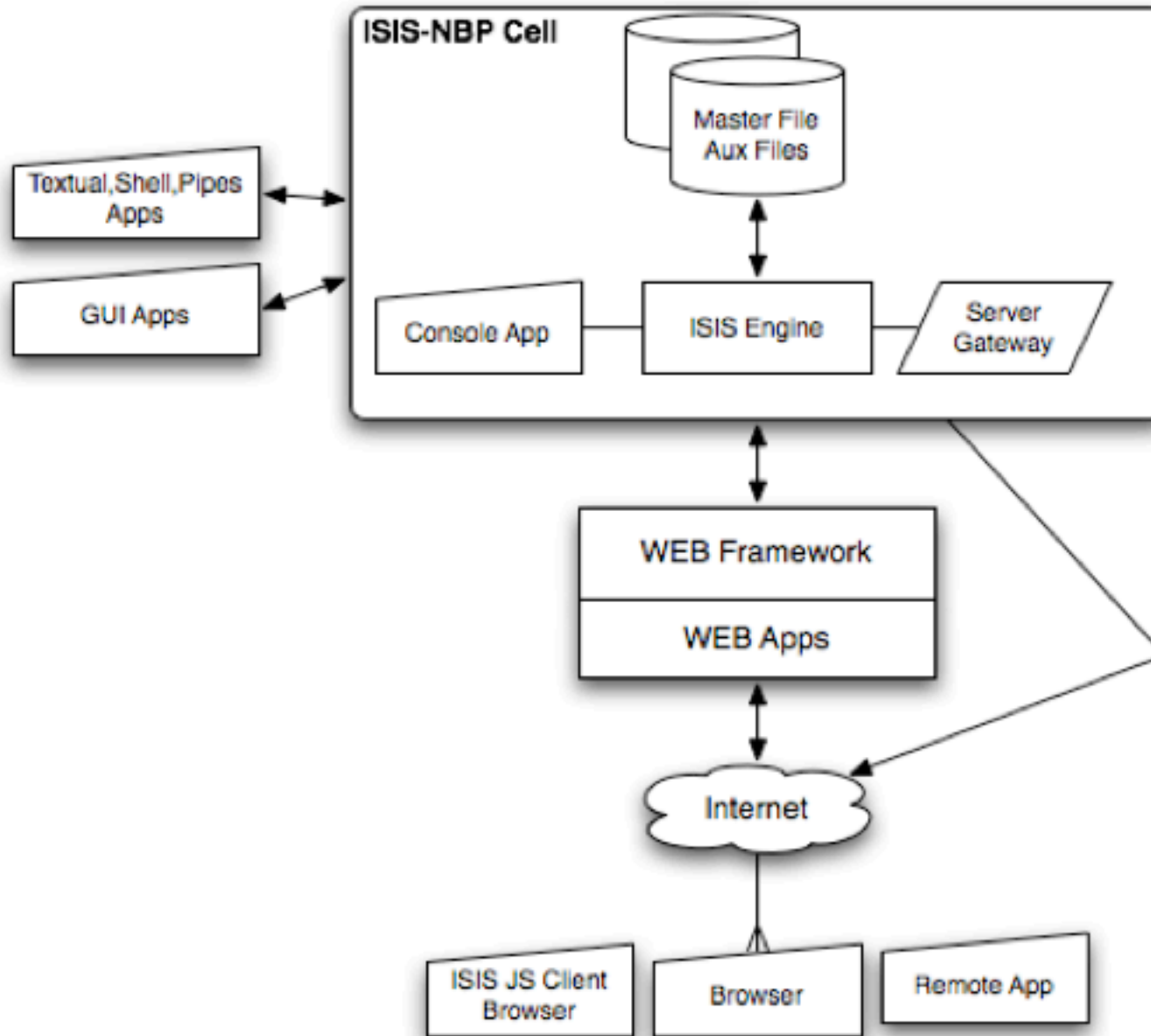

# Scenarios

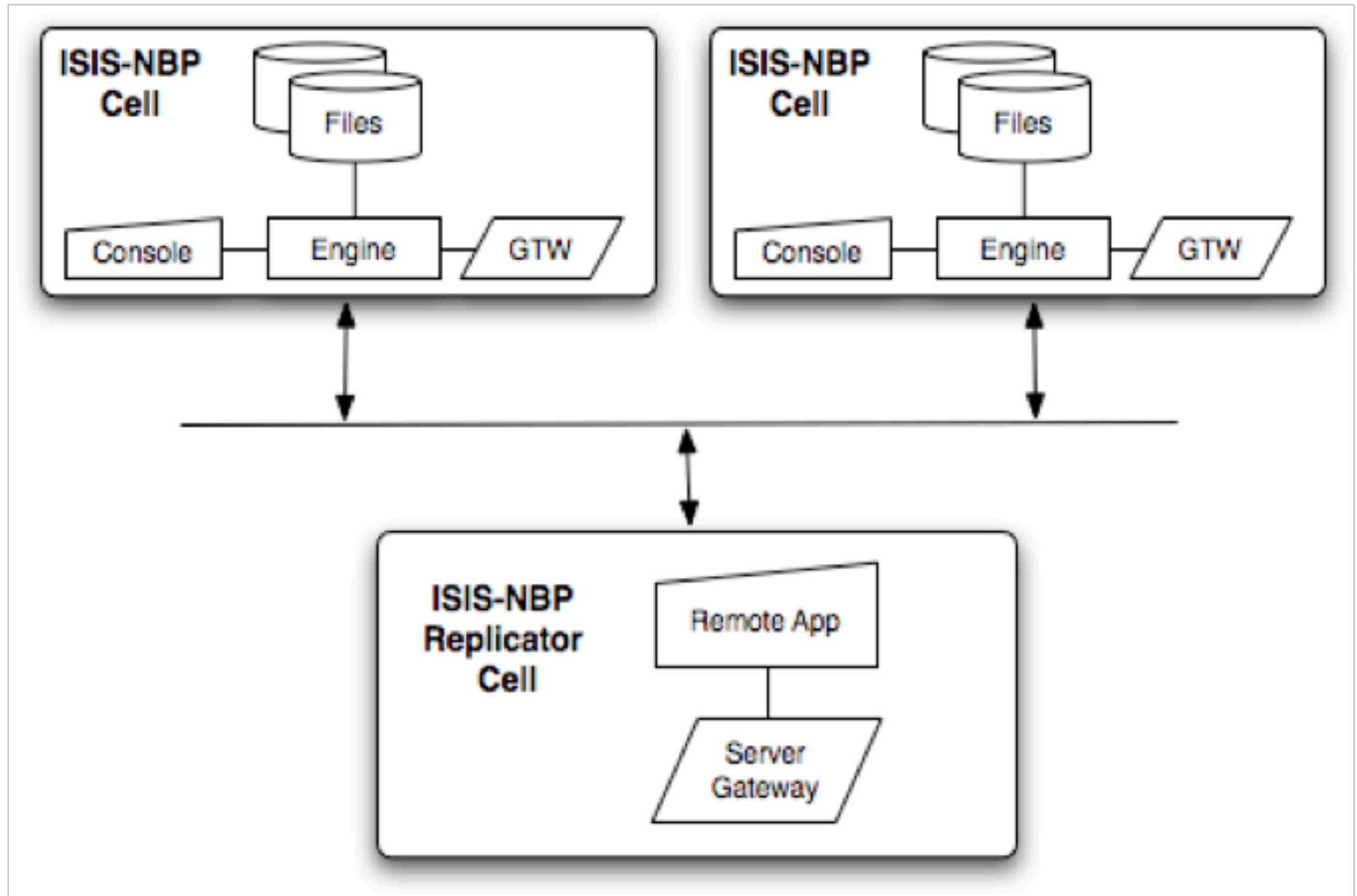

# Scenarios

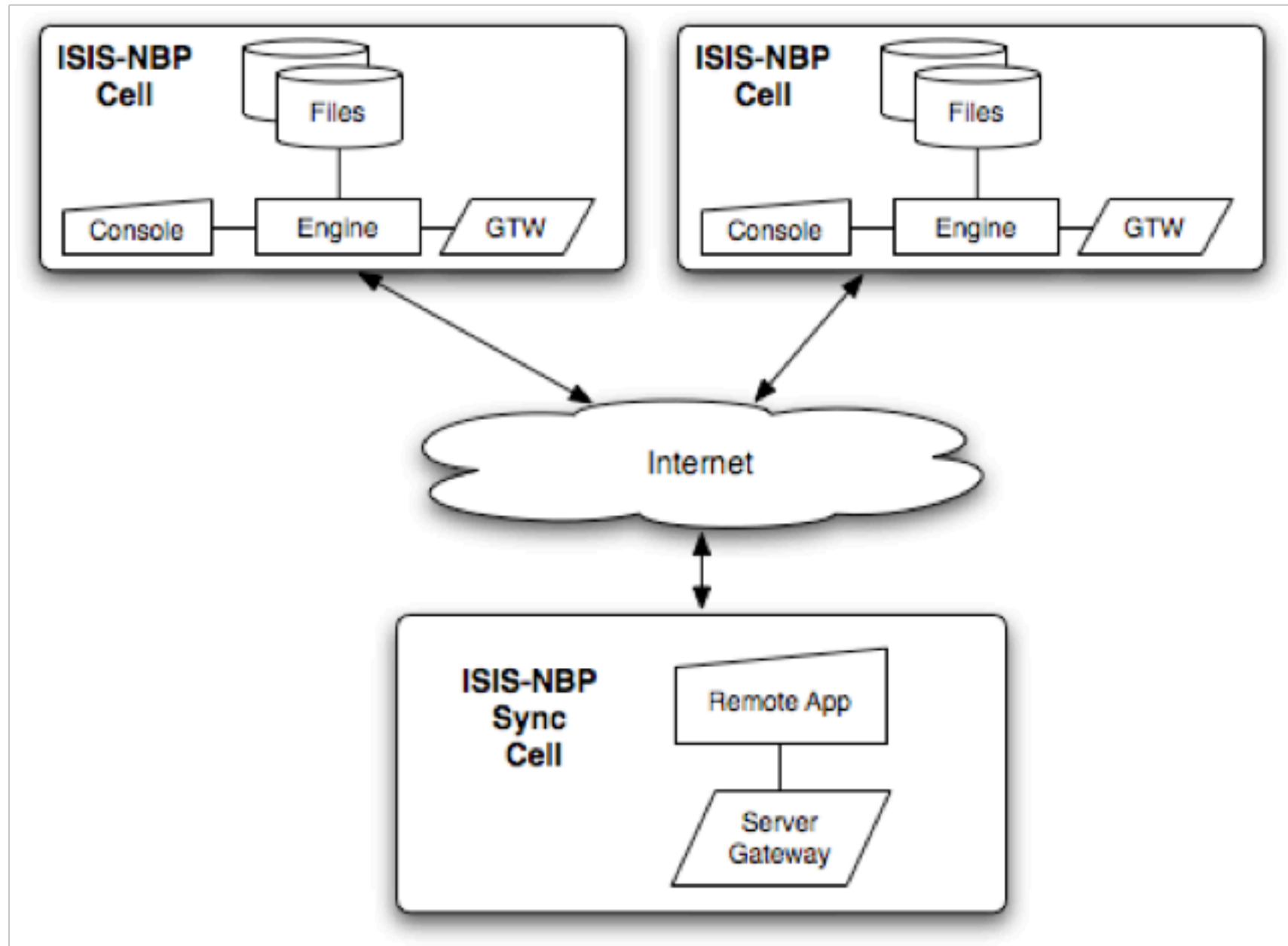

# Scenarios

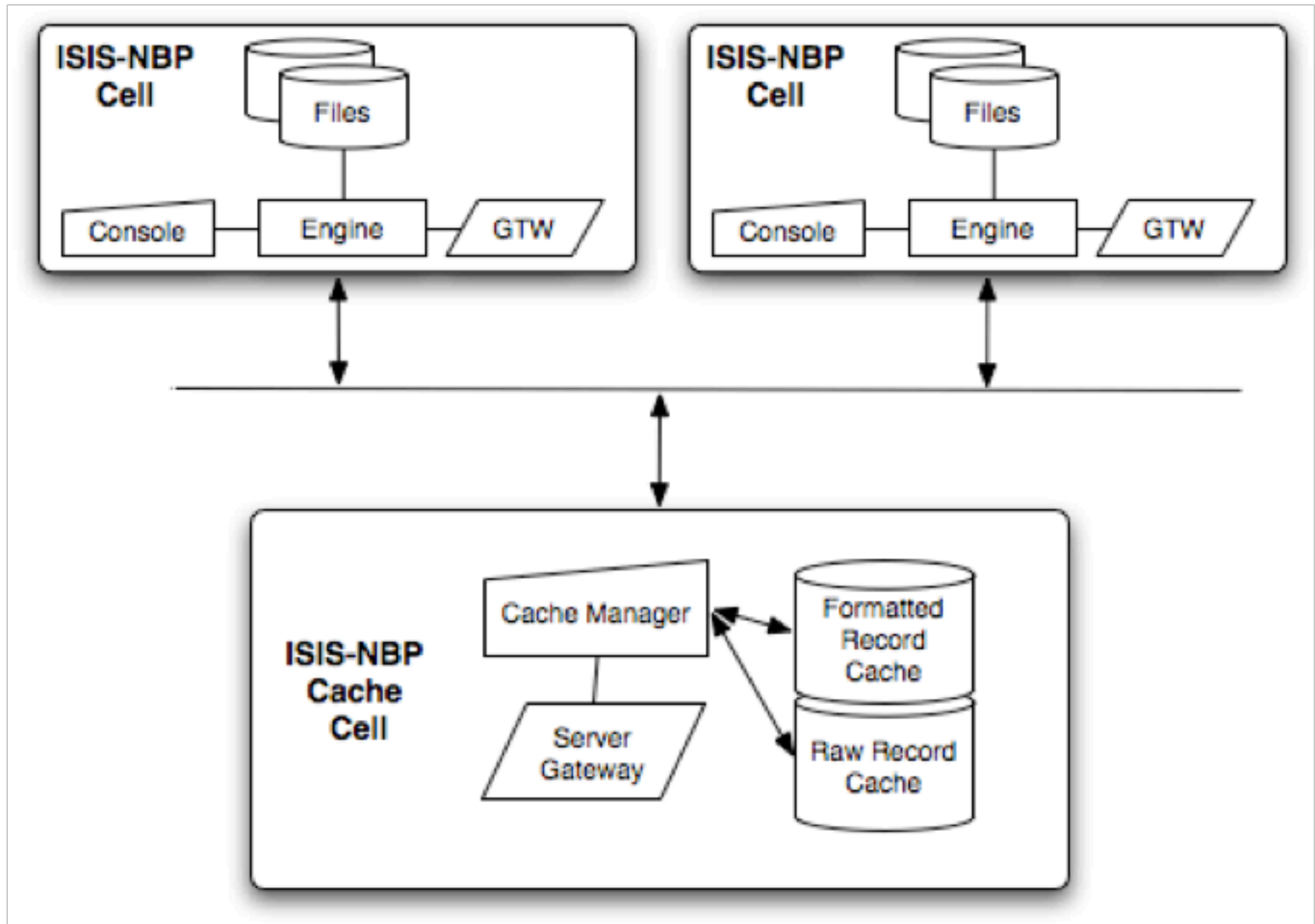

# Scenarios

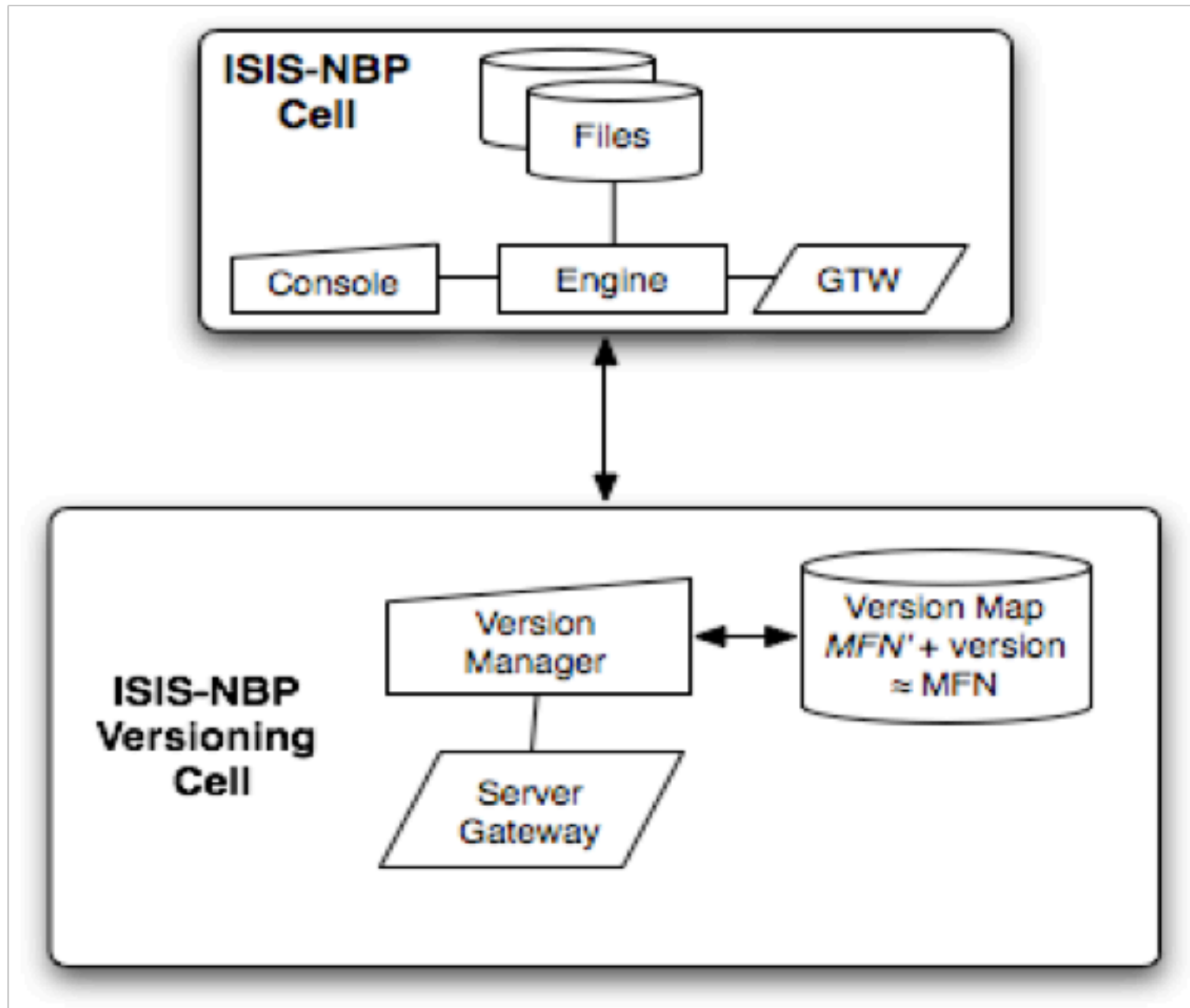



# ISIS-NBP in Action

# ISIS-NBP in action

- **Interactive Console**

- ▶ browse collection
- ▶ pft
- ▶ unicode / encoding / gizmo
- ▶ cascaded configuration
- ▶ il8n
- ▶ remote console

- **Gateway**

- ▶ remote console
- ▶ embedded HTML
- ▶ URL based (actionlets)
- ▶ HTTP REST
- ▶ XML-RPC





# Project Status

# ISIS-NBP Cell Status

# ISIS-NBP Cell Status



Engine

# ISIS-NBP Cell Status

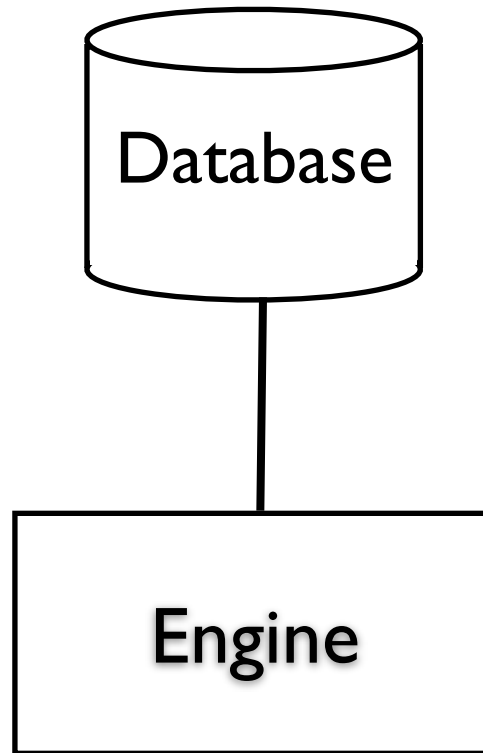

# ISIS-NBP Cell Status

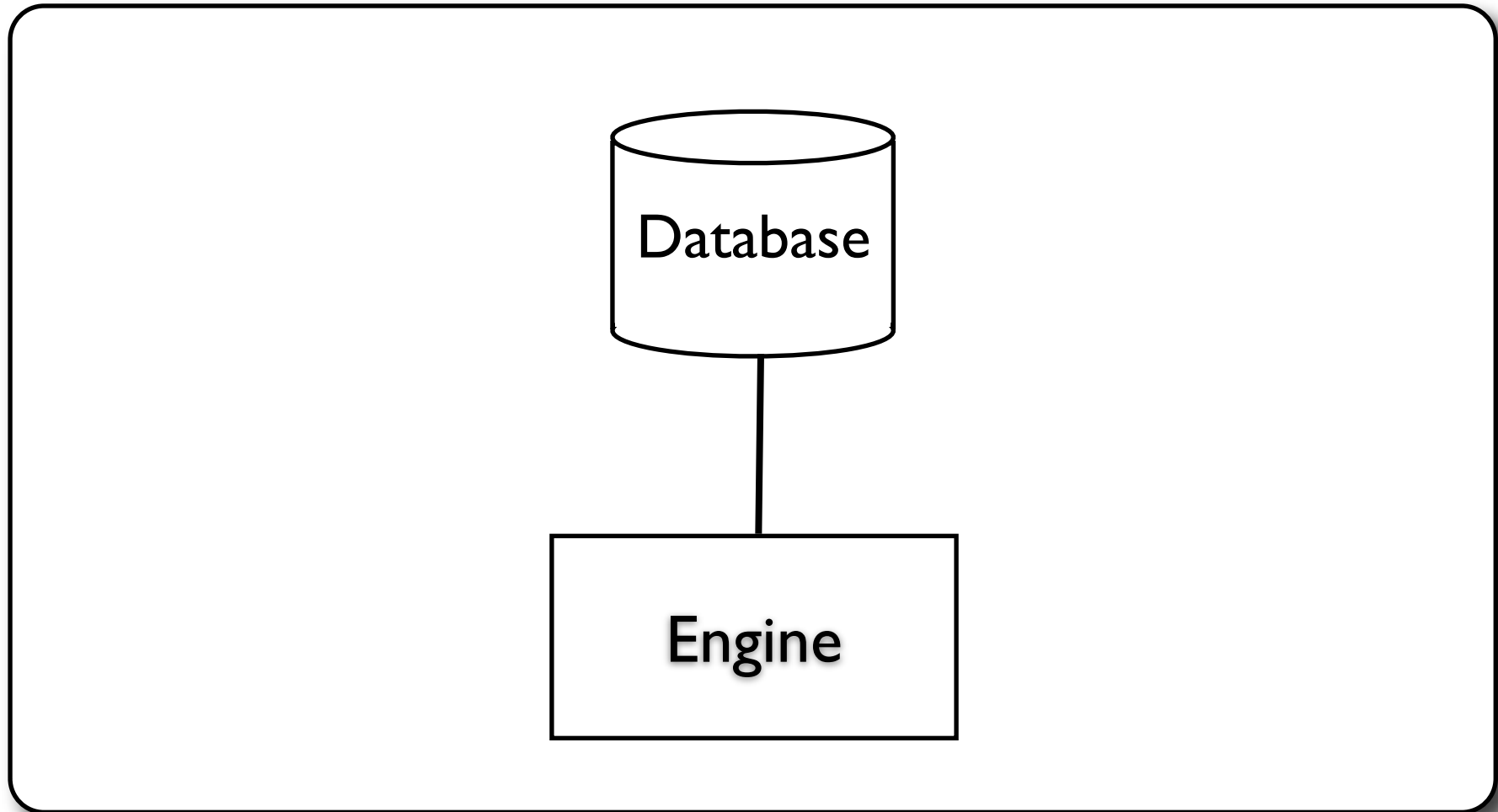

# ISIS-NBP Cell Status

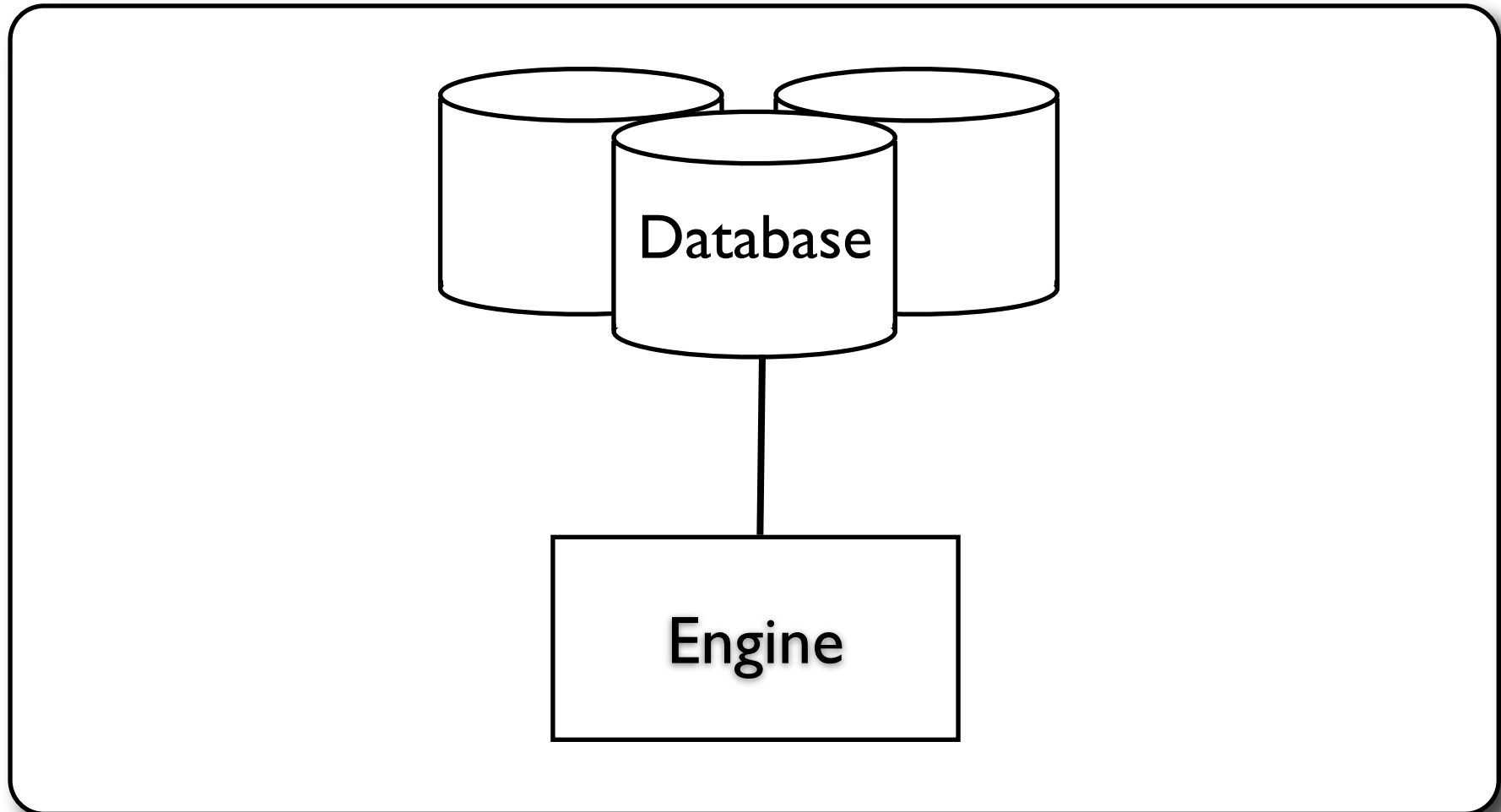

# ISIS-NBP Cell Status

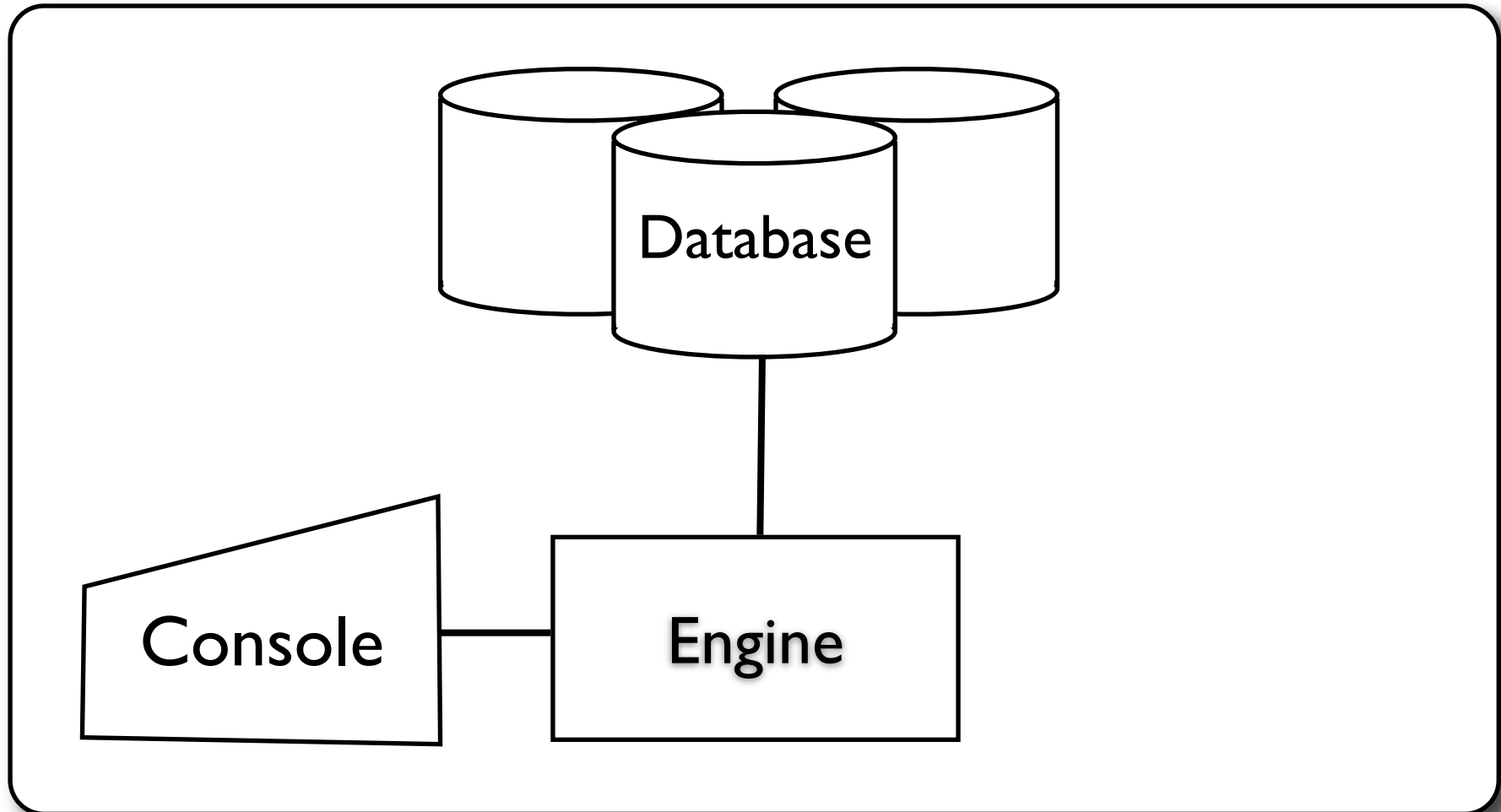



# ISIS-NBP Cell Status

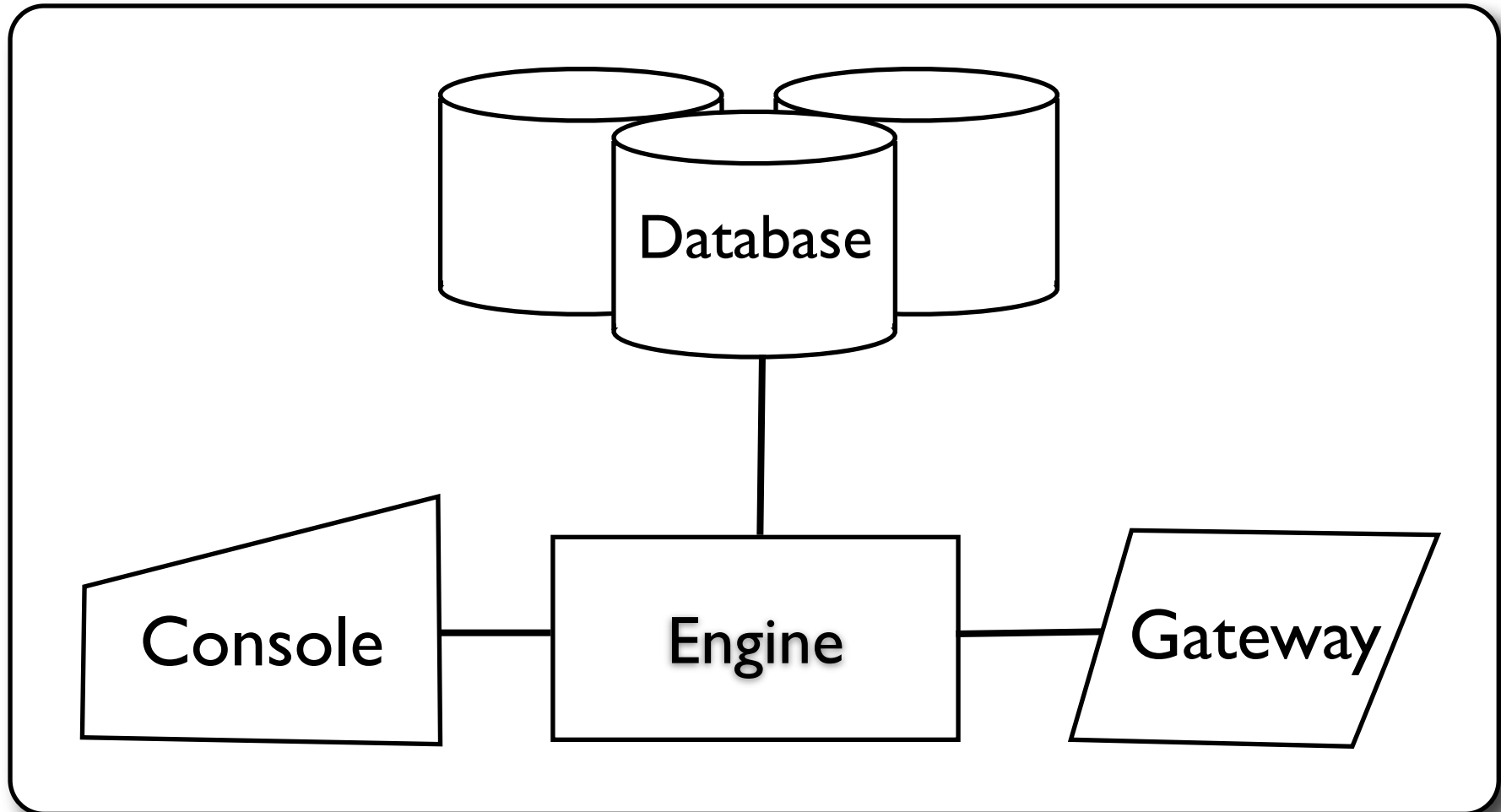

# Database Status

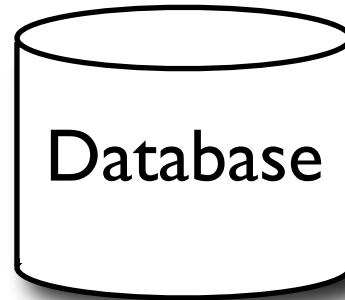

.mst, .xrf, .fdt  
record undelete  
configurable capacity/ layout

.iso  
indexing  
other DB backends  
error recovery  
defragmentation

# Database Status

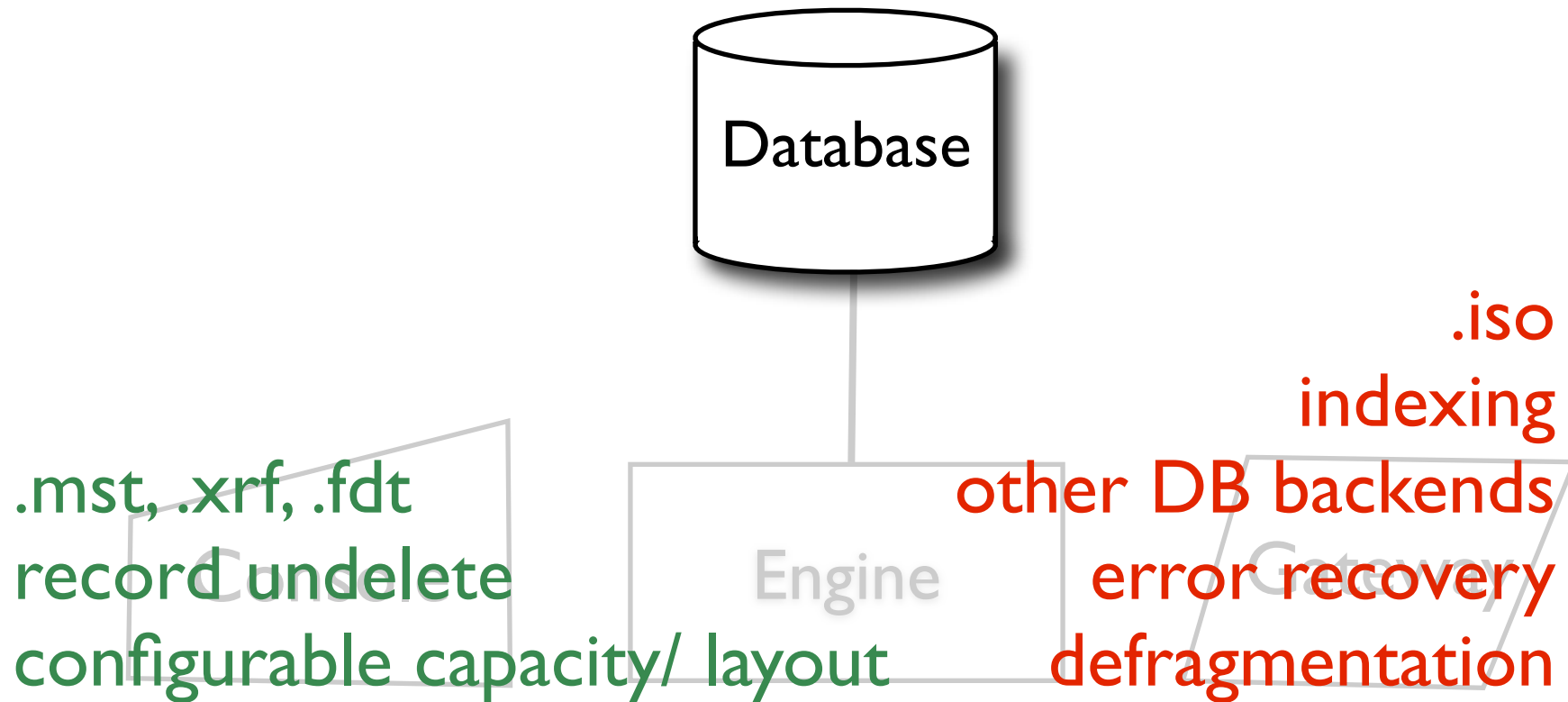

# Database Status

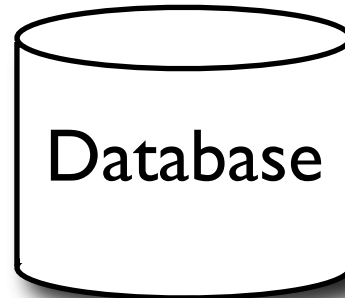

.mst, .xrf, .fdt  
record undelete  
configurable capacity/  
layout

Engine

other DB backends  
error recovery  
defragmentation

.iso  
indexing

Gateway

# Database Status

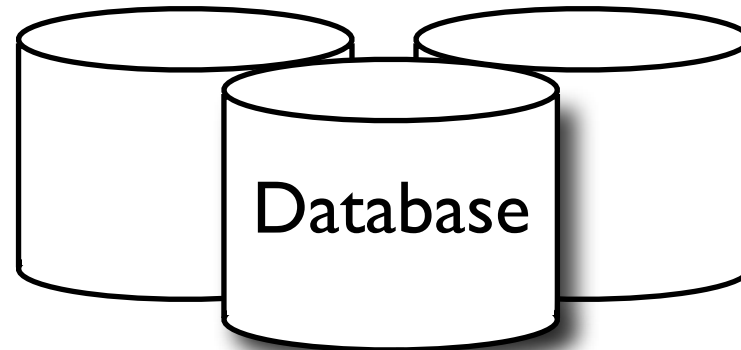

.mst, .xrf, .fdt  
record undelete  
configurable capacity/  
layout

Engine

.iso  
indexing  
other DB backends  
error recovery  
defragmentation

# Console Status

command completion  
command history  
syntax highlight  
O.S. integration  
task automation support  
embedded help

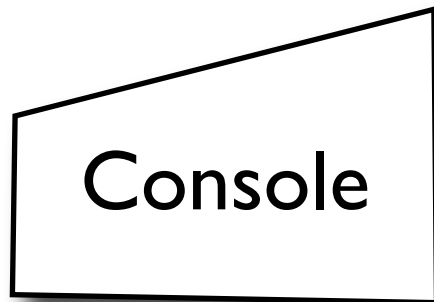
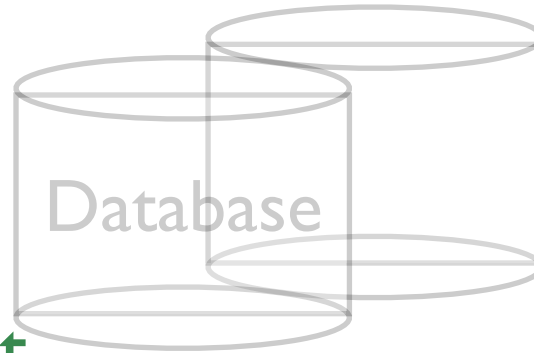

# Console Status

command completion  
command history  
syntax highlight  
O.S. integration  
task automation support  
embedded help

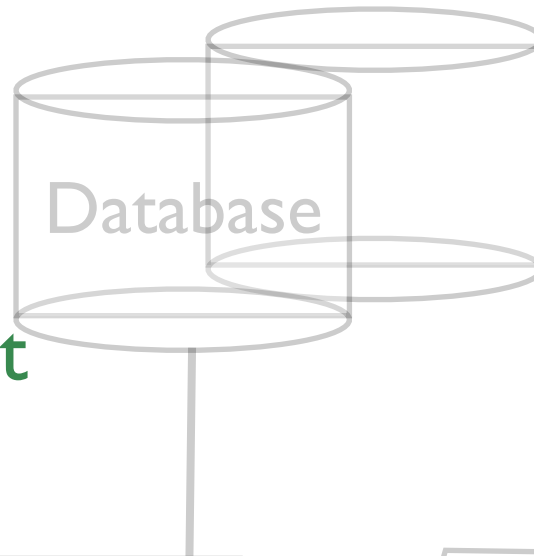
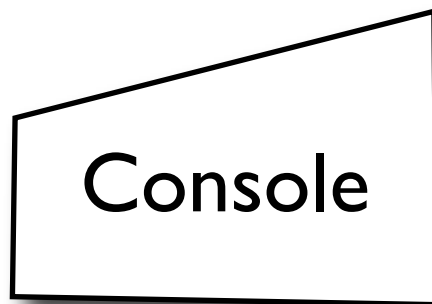

# Console Status

command completion  
command history  
syntax highlight  
O.S. integration  
task automation support  
embedded help

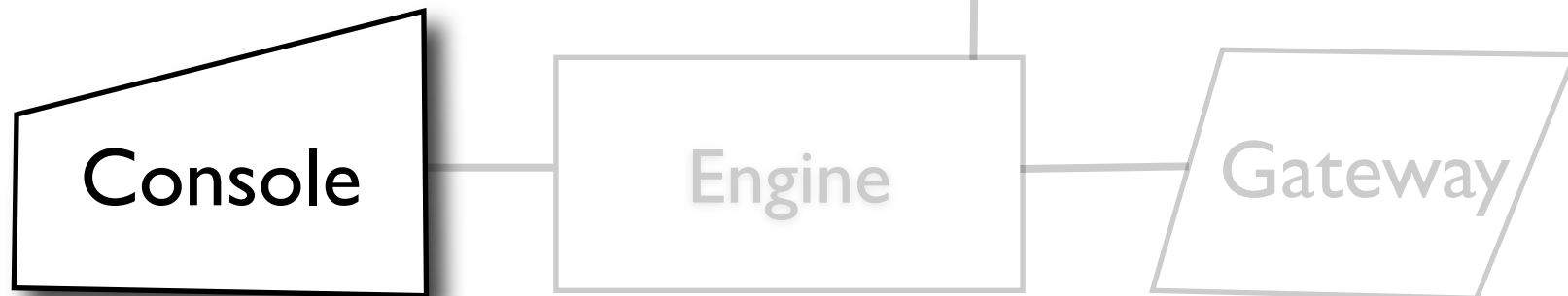



# Engine Status

UNICODE

i18n

formatting language 76%

isis → object model

cascaded configuration

new concept: Collections

generic database model

optimizations

formatting language 24%

IsisScript

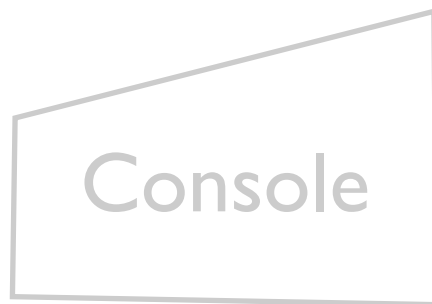

# Engine Status

UNICODE

i18n

formatting language 76%

isis → object model

cascaded configuration

new concept: Collections

generic database model

optimizations

formatting language 24%

IsisScript

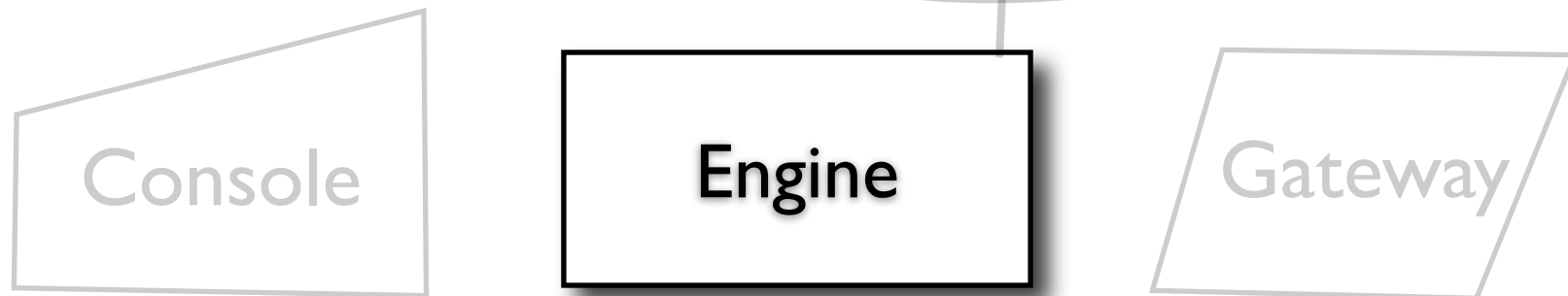

# Engine Status

UNICODE

i18n

formatting language 76%

isis → object model

cascaded configuration

new concept: Collections

generic database model

optimizations

formatting language 24%

IsisScript



# Gateway Status

SSH Remote Console  
HTML interface  
HTTP Restful API  
XML-RCP API

WINISIS-like HTML interface  
OAI-PMH support  
JSON API  
WebDAV API  
SOAP/WSDL API  
RSS support

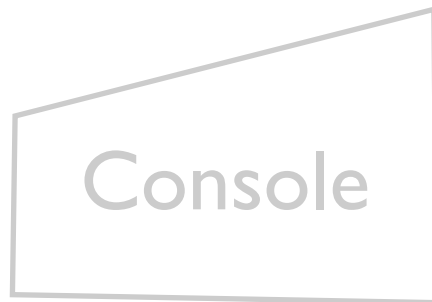

# Gateway Status

SSH Remote Console  
HTML interface  
HTTP Restful API  
XML-RCP API

WINISIS-like HTML interface  
OAI-PMH support  
JSON API  
WebDAV API  
SOAP/WSDL API  
RSS support

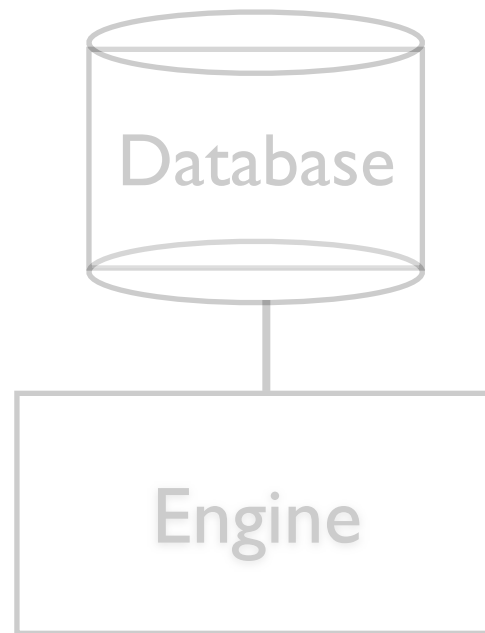
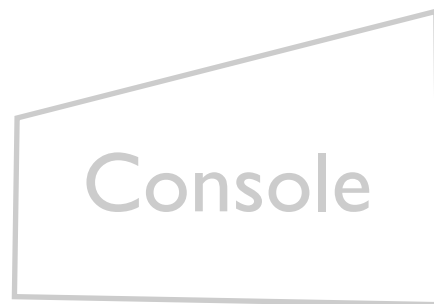

# Gateway Status

SSH Remote Console  
HTML interface  
HTTP Restful API  
XML-RCP API

WINISIS-like HTML interface  
OAI-PMH support  
JSON API  
WebDAV API  
SOAP/WSDL API  
RSS support

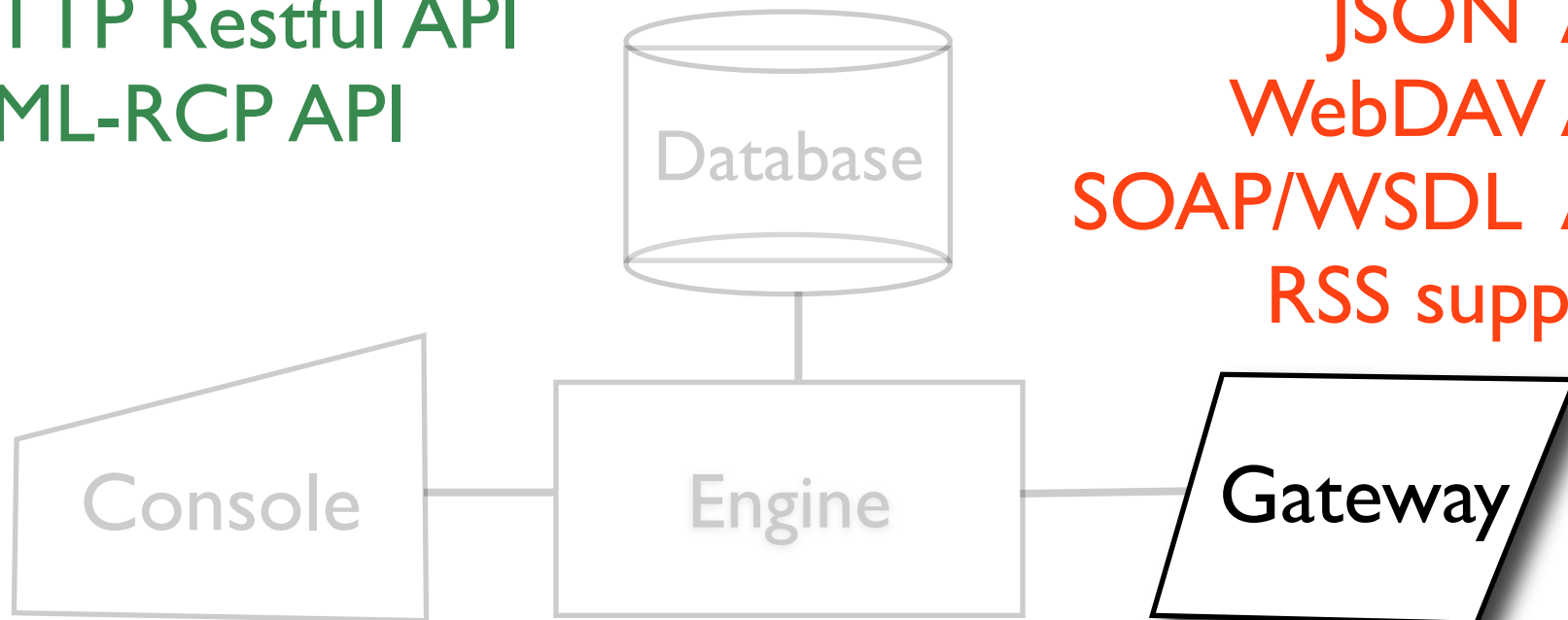

# Community Resources

## **Mailing lists**

[isisnbp-users@listas.bireme.br](mailto:isisnbp-users@listas.bireme.br)

[isisnbp-devel@listas.bireme.br](mailto:isisnbp-devel@listas.bireme.br)

## **Project Web Site (Trac)**

<http://reddes.bvsaude.org/projects/isisnbp>

- Wiki
- Subversion
- Documentation (under construction)
- Patches

# Acknowledgements

- BIRME/PAHO/WHO
- Unesco
- GPr Sistemas
- ISIS-NBP Team
- External collaborators



Abel L. Packer

João Chaves Jr

Adalberto Tardelli

Renato Murasaki

Ernesto Spinak

Rodrigo Senra

Francisco José Lopes

Heitor Barbieri

- ISIS-NBP Team
- External collaborators

# Acknowledgements

- BIRME/PAHO/WHO
- Unesco
- GPr Sistemas
- ISIS-NBP Team
- External collaborators

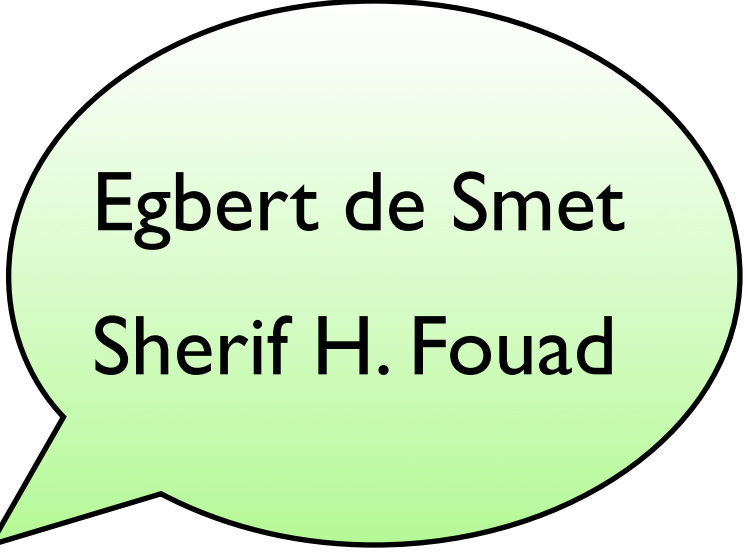

Egbert de Smet  
Sherif H. Fouad

**Rodrigo Dias Arruda Senra**

<http://rodrigo.senra.nom.br>

[rsenra@acm.org](mailto:rsenra@acm.org)

Obrigado a todos  
pela atenção.

**Rodrigo Dias Arruda Senra**

<http://rodrigo.senra.nom.br>

[rsenra@acm.org](mailto:rsenra@acm.org)

# Who is using Python ?



# Who is using Python ?

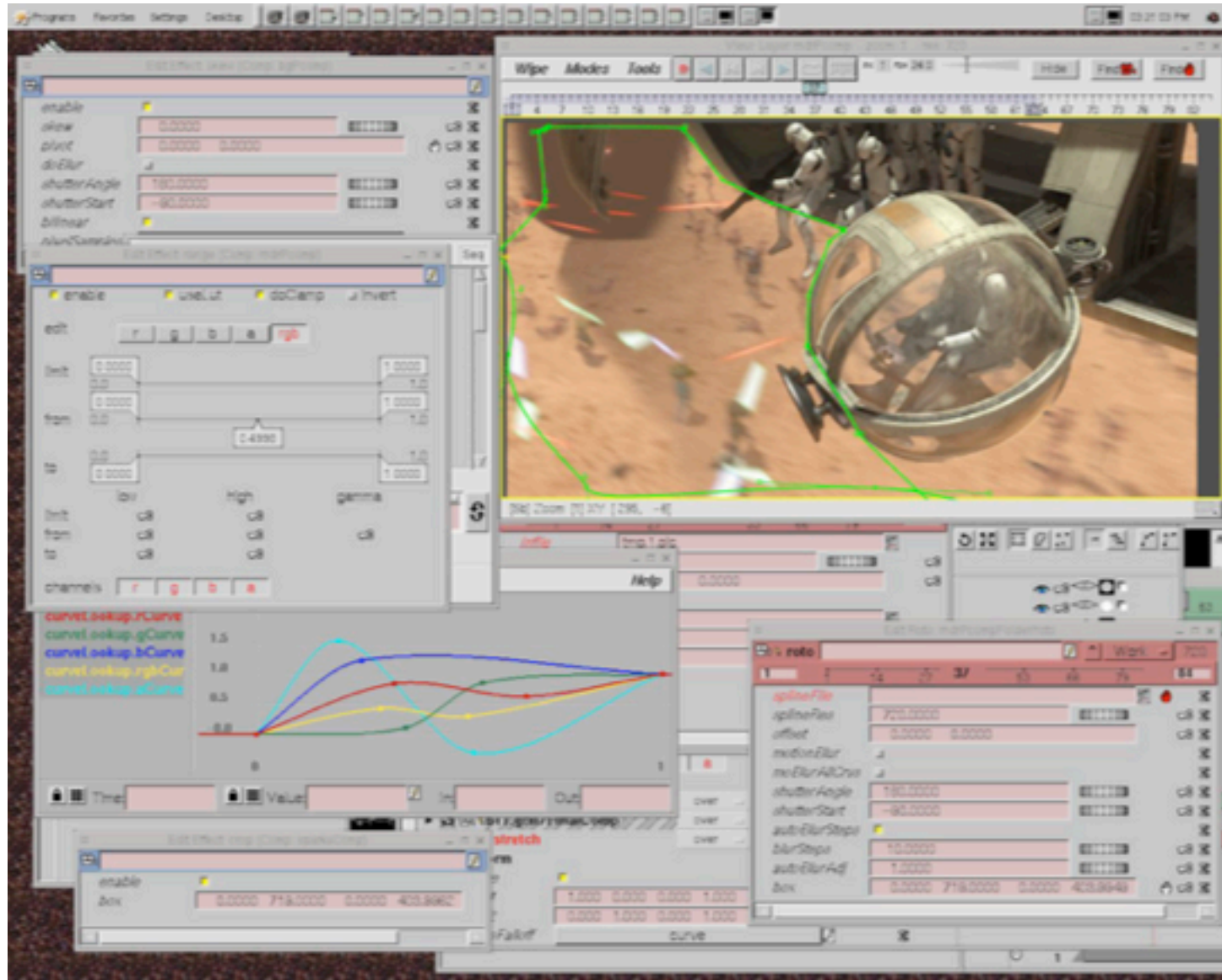

# Who is using Python ?



# Who is using Python ?





# Python is ...

- **general purpose** Programming Language
- focused on **developer productivity**
- **multi-platform** and **multi-paradigm**
- **rich**: batteries included + 3rd party extensions
- truly **floss** software
- **easy** to extend and embed
- **mature** (created in 1989, released 1991)